

# Karate1 Premier League - Fukuoka 2023

2023.06.09 - 2023.06.11

Fukuoka

JAPAN,JPN





# Karate1 Premier League - Fukuoka 2023

JAPAN  
Fukuoka

2023.06.09 - 2023.06.11



## NUMBER OF ENTRIES

#	Code	Country	Male Entries	Female Entries	Total Entries	Total Athletes
1	ALG	ALGERIA	3	4	7	7
2	AUS	AUSTRALIA	2	2	4	4
3	AUT	AUSTRIA	2	3	5	5
4	AZE	AZERBAIJAN	1	1	2	2
5	BEL	BELGIUM	7	1	8	8
6	BRA	BRAZIL	4	1	5	5
7	BUL	BULGARIA	1	1	2	2
8	CAN	CANADA	1	2	3	3
9	CHI	CHILE	2	1	3	3
10	TPE	CHINESE TAIPEI	5	4	9	9
11	CRO	CROATIA	2	4	6	6
12	CUR	CURACAO	1	0	1	1
13	ECU	ECUADOR	0	1	1	1
14	EGY	EGYPT	6	4	10	10
15	ESA	EL SALVADOR	0	1	1	1
16	ENG	ENGLAND	2	0	2	2
17	FIN	FINLAND	1	1	2	2
18	FRA	FRANCE	5	0	5	4
19	GER	GERMANY	5	9	14	14
20	GRE	GREECE	2	2	4	4
21	HKG	HONG KONG, CHINA	2	7	9	9
22	HUN	HUNGARY	1	0	1	1
23	IND	INDIA	1	1	2	2
24	INA	INDONESIA	1	3	4	4
25	ITA	ITALY	11	1	12	12
26	JPN	JAPAN	23	26	49	49
27	JOR	JORDAN	6	0	6	6
28	KAZ	KAZAKHSTAN	14	10	24	24
29	KUW	KUWAIT	5	0	5	5
30	MAS	MALAYSIA	2	3	5	5
31	NED	NETHERLANDS	1	0	1	1
32	NOR	NORWAY	1	0	1	1
33	CHN	PEOPLES REPUBLIC OF CHINA	0	2	2	2
34	PER	PERU	0	1	1	1
35	PHI	PHILIPPINES	0	1	1	1
36	POR	PORTUGAL	1	0	1	1
37	ROU	ROMANIA	1	1	2	2
38	KSA	SAUDI ARABIA	6	0	6	6
39	SVK	SLOVAKIA	4	3	7	7
40	ESP	SPAIN	5	6	11	11
41	SWE	SWEDEN	0	3	3	3
42	SUI	SWITZERLAND	2	8	10	10
43	TUR	TURKIYE	1	2	3	3
44	UKR	UKRAINE	11	7	18	17
45	USA	UNITED STATES	4	2	6	6
46	VEN	VENEZUELA	1	1	2	2
<b>Totals:</b>			156	130	286	284



# Karate1 Premier League - Fukuoka 2023

JAPAN  
Fukuoka

2023.06.09 - 2023.06.11



## Statistics

Participating Countries: 46

Participating Regions: 1

Participating  
Team/Clubs:

122

	Competitors	Entries
Female	130	130
Male	154	156
<b>Total</b>	<b>284</b>	<b>286</b>

### Entries per Category



















	Entries	Teams
Female Kata	27	-
Female Kumite -50 Kg	22	-
Female Kumite -55 Kg	24	-
Female Kumite -61 Kg	16	-
Female Kumite -68 Kg	22	-
Female Kumite 68+ Kg	19	-
Male Kata	31	-
Male Kumite -60 Kg	26	-
Male Kumite -67 Kg	28	-
Male Kumite -75 Kg	25	-
Male Kumite -84 Kg	26	-
Male Kumite 84+ Kg	20	-
<b>Totals:</b>	<b>286</b>	<b>0</b>

# Female Kata - Round Robin (each against each)

Karate1 Premier League - Fukuoka 2023, Fukuoka, JPN

Tatami

Pool  
1/8

1	 (*9) XENOU G. (GRE)	068 Papuren	3860	 (*9) XENOU G. (GRE)
2	 (*23) TUNG Y. (HKG)	064 Ohan Dai	3760	
3	 (*16) MINANO L. (SUI)	068 Papuren	3720	 (*6) OHUCHI M. (JPN)
4	 (*6) OHUCHI M. (JPN)	061 Nipaipo	4040	
5	 (*23) TUNG Y. (HKG)	008 Chatanyara Kushanku	3780	 (*23) TUNG Y. (HKG)
6	 (*16) MINANO L. (SUI)	064 Ohan Dai	3640	
7	 (*9) XENOU G. (GRE)	002 Anan Dai	3810	 (*6) OHUCHI M. (JPN)
8	 (*6) OHUCHI M. (JPN)	068 Papuren	4150	
9	 (*9) XENOU G. (GRE)	008 Chatanyara Kushanku	3640	 (*16) MINANO L. (SUI)
10	 (*16) MINANO L. (SUI)	047 Kururunfa	3670	
11	 (*23) TUNG Y. (HKG)	068 Papuren	3830	 (*6) OHUCHI M. (JPN)
12	 (*6) OHUCHI M. (JPN)	092 Suparinpei	4210	



1. ONO HIKARU (JPN)
2. LAU MO SHEUNG GRACE (HKG)
3. OHUCHI MIRISA (JPN)
3. SHIMIZU KIYOU (JPN)
5. SHIMIZU NATSUKI (JPN)
5. YAMADA NODOKA (JPN)
7. KOKUMAI SAKURA (USA)
7. ONO MAHO (JPN)

\*Seeded









Referees:			

# Female Kata - Round Robin (each against each)

Karate1 Premier League - Fukuoka 2023, Fukuoka, JPN

Tatami

Pool  
2/8

1	 (*13) AZUMA S. (JPN)	009 Chibana No Kushanku3900	 (*13) AZUMA S. (JPN)
2	 (*17) CHIEN H. (TPE)	092 Suparinpei 3790	
3	 (*13) AZUMA S. (JPN)	008 Chatanyara Kushanku3920	 (*3) KOKUMAI S. (USA)
4	 (*3) KOKUMAI S. (USA)	008 Chatanyara Kushanku4100	
5	 (*17) CHIEN H. (TPE)	001 Anan 3720	 (*3) KOKUMAI S. (USA)
6	 (*3) KOKUMAI S. (USA)	068 Papuren 4030	



1. ONO HIKARU (JPN)
2. LAU MO SHEUNG GRACE (HKG)
3. OHUCHI MIRISA (JPN)
3. SHIMIZU KIYOU (JPN)
5. SHIMIZU NATSUKI (JPN)
5. YAMADA NODOKA (JPN)
7. KOKUMAI SAKURA (USA)
7. ONO MAHO (JPN)

\*Seeded

Referees:			

# Female Kata - Round Robin (each against each)

Karate1 Premier League - Fukuoka 2023, Fukuoka, JPN

Tatami

Pool  
3/8

1	(*10) SHIMIZU N. (JPN)	092 Suparinpei	3920	(*10) SHIMIZU N. (JPN)
2	(*14) KATO K. (JPN)	009 Chibana No Kushanku	3860	
3	(*11) LO S. (HKG)	068 Papuren	3980	(*11) LO S. (HKG)
4	(*7) JUETTNER J. (GER)	021 Gojushiho Sho	3900	
5	(*14) KATO K. (JPN)	068 Papuren	4020	(*11) LO S. (HKG)
6	(*11) LO S. (HKG)	092 Suparinpei	4030	
7	(*10) SHIMIZU N. (JPN)	047 Kururunfa	4140	(*10) SHIMIZU N. (JPN)
8	(*7) JUETTNER J. (GER)	092 Suparinpei	3910	
9	(*10) SHIMIZU N. (JPN)	068 Papuren	4120	(*10) SHIMIZU N. (JPN)
10	(*11) LO S. (HKG)	008 Chatanyara Kushanku	4000	
11	(*14) KATO K. (JPN)	008 Chatanyara Kushanku	3950	(*14) KATO K. (JPN)
12	(*7) JUETTNER J. (GER)	099 Unsu	3860	



1. ONO HIKARU (JPN)
2. LAU MO SHEUNG GRACE (HKG)
3. OHUCHI MIRISA (JPN)
3. SHIMIZU KIYOU (JPN)
5. SHIMIZU NATSUKI (JPN)
5. YAMADA NODOKA (JPN)
7. KOKUMAI SAKURA (USA)
7. ONO MAHO (JPN)

\*Seeded







Referees:			

# Female Kata - Round Robin (each against each)

Karate1 Premier League - Fukuoka 2023, Fukuoka, JPN

Tatami

Pool  
4/8

1	 (*22) IWAMOTO E. (JPN)	
	001 Anan	3990
2	 (*21) MOTA N. (BRA)	
	092 Suparinpei	3900
3	 (*22) IWAMOTO E. (JPN)	
	068 Papuren	4060
4	 (*2) LAU M. (HKG)	
	068 Papuren	4170
5	 (*21) MOTA N. (BRA)	
	064 Ohan Dai	3870
6	 (*2) LAU M. (HKG)	
	097 Tomari Bassai	4120



1. ONO HIKARU (JPN)
2. LAU MO SHEUNG GRACE (HKG)
3. OHUCHI MIRISA (JPN)
3. SHIMIZU KIYOU (JPN)
5. SHIMIZU NATSUKI (JPN)
5. YAMADA NODOKA (JPN)
7. KOKUMAI SAKURA (USA)
7. ONO MAHO (JPN)

\*Seeded

Referees:			

# Female Kata - Round Robin (each against each)

Karate1 Premier League - Fukuoka 2023, Fukuoka, JPN

Tatami

Pool  
5/8

1	(*20) PUTRI APRILIA K. (INA)	
	068 Papuren	3800
2	(*12) VANUSANIKOVA J. (SVK)	(*20) PUTRI APRILIA K. (INA)
	068 Papuren	3610
3	(*20) PUTRI APRILIA K. (INA)	
	002 Anan Dai	3870
4	(*5) ONO M. (JPN)	(*5) ONO M. (JPN)
	068 Papuren	4160
5	(*12) VANUSANIKOVA J. (SVK)	
	002 Anan Dai	3680
6	(*5) ONO M. (JPN)	(*5) ONO M. (JPN)
	092 Suparinpei	4090



1. ONO HIKARU (JPN)
2. LAU MO SHEUNG GRACE (HKG)
3. OHUCHI MIRISA (JPN)
3. SHIMIZU KIYOU (JPN)
5. SHIMIZU NATSUKI (JPN)
5. YAMADA NODOKA (JPN)
7. KOKUMAI SAKURA (USA)
7. ONO MAHO (JPN)

\*Seeded

Referees:			











# Female Kata - Round Robin (each against each)

Karate1 Premier League - Fukuoka 2023, Fukuoka, JPN

Tatami

Pool  
6/8

- 1  (\*18) LAOS-LOO C. (CAN)  
009 Chibana No Kushanku 3730 |  (\*19) GARCIA LOZANO P. (ESP)  
068 Papuren 3990
- 2  (\*19) GARCIA LOZANO P. (ESP)  
068 Papuren 3990
- 3  (\*18) LAOS-LOO C. (CAN)  
008 Chatanyara Kushanku 3890 |  (\*4) SHIMIZU K. (JPN)  
068 Papuren 4190
- 4  (\*4) SHIMIZU K. (JPN)  
068 Papuren 4190
- 5  (\*19) GARCIA LOZANO P. (ESP)  
008 Chatanyara Kushanku 4030 |  (\*4) SHIMIZU K. (JPN)  
065 Oyadomari No Passai 4190
- 6  (\*4) SHIMIZU K. (JPN)  
065 Oyadomari No Passai 4190



1. ONO HIKARU (JPN)
2. LAU MO SHEUNG GRACE (HKG)
3. OHUCHI MIRISA (JPN)
3. SHIMIZU KIYOU (JPN)
5. SHIMIZU NATSUKI (JPN)
5. YAMADA NODOKA (JPN)
7. KOKUMAI SAKURA (USA)
7. ONO MAHO (JPN)

\*Seeded



















Referees:			

# Female Kata - Round Robin (each against each)

Karate1 Premier League - Fukuoka 2023, Fukuoka, JPN

Tatami

Pool  
7/8

1	 (*27) YAMADA N. (JPN)	068 Papuren	3970	 (*27) YAMADA N. (JPN)
2	 (*26) HORIBA H. (JPN)	008 Chatanyara Kushanku	3940	
3	 (*15) MARK M. (SUI)	068 Papuren	3740	 (*8) HESHAM A. (EGY)
4	 (*8) HESHAM A. (EGY)	041 Kanku Sho	3920	
5	 (*26) HORIBA H. (JPN)	097 Tomari Bassai	3940	 (*26) HORIBA H. (JPN)
6	 (*15) MARK M. (SUI)	047 Kururunfa	3800	
7	 (*27) YAMADA N. (JPN)	047 Kururunfa	4080	 (*27) YAMADA N. (JPN)
8	 (*8) HESHAM A. (EGY)	021 Gojushiho Sho	3930	
9	 (*27) YAMADA N. (JPN)	092 Suparinpei	4080	 (*27) YAMADA N. (JPN)
10	 (*15) MARK M. (SUI)	002 Anan Dai	3740	32
11	 (*26) HORIBA H. (JPN)	068 Papuren	3970	 (*26) HORIBA H. (JPN)
12	 (*8) HESHAM A. (EGY)	020 Gojushiho Dai	3810	



1. ONO HIKARU (JPN)
2. LAU MO SHEUNG GRACE (HKG)
3. OHUCHI MIRISA (JPN)
3. SHIMIZU KIYOU (JPN)
5. SHIMIZU NATSUKI (JPN)
5. YAMADA NODOKA (JPN)
7. KOKUMAI SAKURA (USA)
7. ONO MAHO (JPN)

\*Seeded









Referees:			

# Female Kata - Round Robin (each against each)

Karate1 Premier League - Fukuoka 2023, Fukuoka, JPN

Tatami

Pool  
8/8

1	 (*24) WONG S. (HKG)	068 Papuren	3900	 (*24) WONG S. (HKG)
2	 (*25) DAHLEB N. (ALG)	020 Gojushiho Dai	3610	
3	 (*24) WONG S. (HKG)	002 Anan Dai	3980	 (*1) ONO H. (JPN)
4	 (*1) ONO H. (JPN)	090 Shisochin	4210	
5	 (*25) DAHLEB N. (ALG)	099 Unsu	3770	 (*1) ONO H. (JPN)
6	 (*1) ONO H. (JPN)	047 Kururunfa	4210	



1. ONO HIKARU (JPN)
2. LAU MO SHEUNG GRACE (HKG)
3. OHUCHI MIRISA (JPN)
3. SHIMIZU KIYOU (JPN)
5. SHIMIZU NATSUKI (JPN)
5. YAMADA NODOKA (JPN)
7. KOKUMAI SAKURA (USA)
7. ONO MAHO (JPN)

\*Seeded

Referees:			

# Pool winner-Female Kata

Karate1 Premier League - Fukuoka 2023, Fukuoka, JPN

Tatami

Pool  
1/1

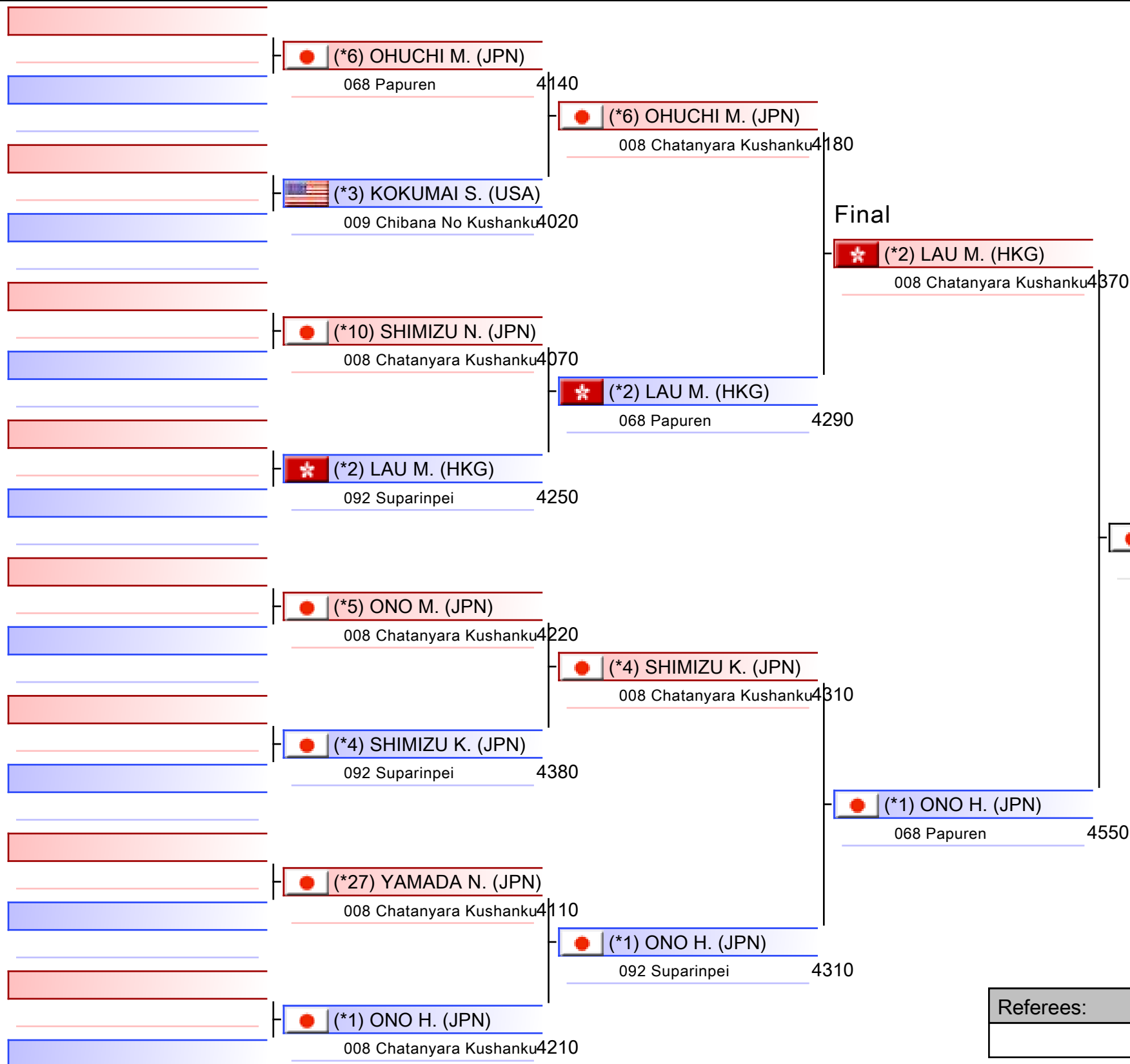

1. ONO HIKARU (JPN)
2. LAU MO SHEUNG GRACE (HKG)
3. OHUCHI MIRISA (JPN)
3. SHIMIZU KIYOU (JPN)
5. SHIMIZU NATSUKI (JPN)
5. YAMADA NODOKA (JPN)
7. KOKUMAI SAKURA (USA)
7. ONO MAHO (JPN)

\*Seeded

Referees:			

# Female Kata

Karate1 Premier League - Fukuoka 2023

Tatami

Pool

1,2,3,4,5,6,7,8

(c)sportdata GmbH & Co KG 2000-2023 (2023-06-11 18:09) v 10.0.1 build 1 (2023-05-19 20:00 CET) License: Online\_Event\_ID-705\_Karate1PremierLeagueFukuoka2023 (expire 2023-06-25)

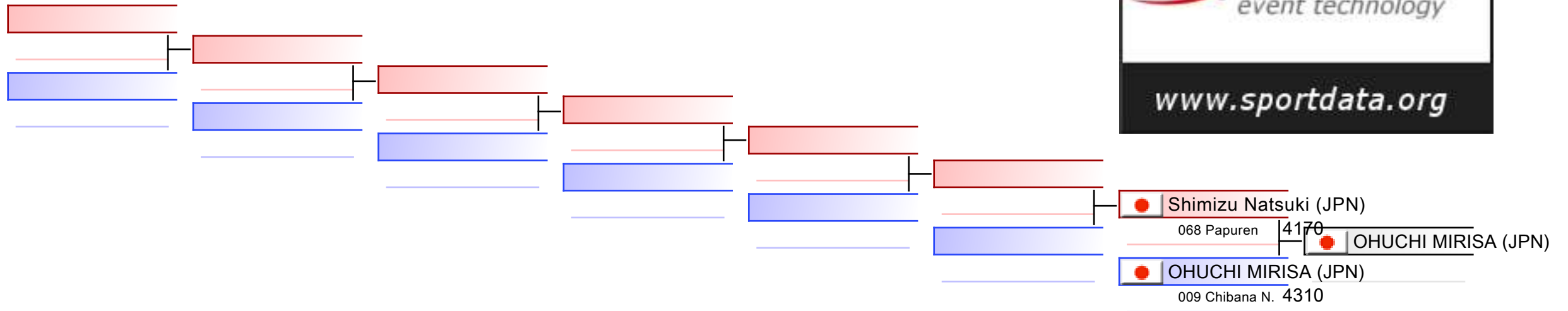

## REPECHAGE: (1,2,3,4,5,6,7,8)

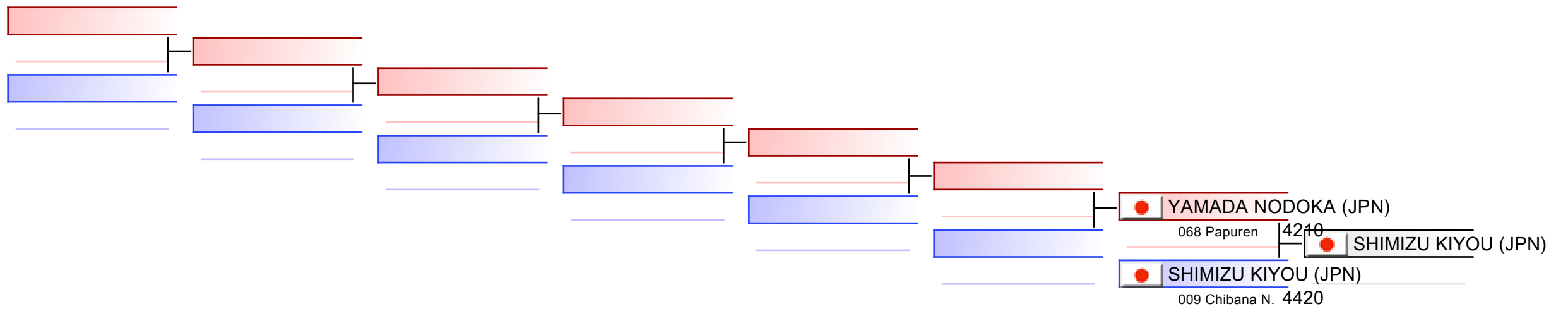

Referees:							
-----------	--	--	--	--	--	--	--

# Female Kumite -50 Kg - Round Robin (each against each)

Karate1 Premier League - Fukuoka 2023, Fukuoka, JPN

Tatami

Pool  
1/6

1	(*19) CHANDRAN S. (MAS)	1	(*9) PLANK B. (AUT)
	PTS		
2	(*9) PLANK B. (AUT)	3	
3	(*10) TSANG Y. (HKG)	0	
4	(*6) MIYAHARA M. (JPN)	0	
5	(*9) PLANK B. (AUT)	0	(*10) TSANG Y. (HKG)
	PTS		
6	(*10) TSANG Y. (HKG)	3	
	SEN		
7	(*19) CHANDRAN S. (MAS)	3	(*19) CHANDRAN S. (MAS)
8	(*6) MIYAHARA M. (JPN)	3	
9	(*19) CHANDRAN S. (MAS)	3	(*10) TSANG Y. (HKG)
	PTS		
10	(*10) TSANG Y. (HKG)	7	
11	(*9) PLANK B. (AUT)	2	(*6) MIYAHARA M. (JPN)
	PTS		
12	(*6) MIYAHARA M. (JPN)	4	



1. SALAMA REEM AHMED (EGY)
2. GOMEZ MORALES NADIA (ESP)
3. ZHANGBYRBAY MOLDIR (KAZ)
3. SALAZAR YORGELIS (VEN)
5. TSANG YEE TING (HKG)
5. TSUTSUMI SARA (JPN)
7. KRYVA KATERYNA (UKR)
7. PALASHEVSKA YULIIA (UKR)

\*Seeded

Referees:			

# Female Kumite -50 Kg - Round Robin (each against each)

Karate1 Premier League - Fukuoka 2023, Fukuoka, JPN

Tatami

Pool  
2/6

1	(*21) TAHATA R. (JPN)	
	SEN	1    (*7) KRYVA K. (UKR)
2	(*7) KRYVA K. (UKR)	1
	PTS	
3	(*14) PEHAR J. (CRO)	2    (*14) PEHAR J. (CRO)
4	(*3) HUBRICH S. (GER)	1
	PTS	
5	(*7) KRYVA K. (UKR)	4    (*7) KRYVA K. (UKR)
6	(*14) PEHAR J. (CRO)	1
	PTS	
7	(*21) TAHATA R. (JPN)	0    (*3) HUBRICH S. (GER)
8	(*3) HUBRICH S. (GER)	1
	PTS	
9	(*21) TAHATA R. (JPN)	0    (*14) PEHAR J. (CRO)
10	(*14) PEHAR J. (CRO)	1
	PTS	
11	(*7) KRYVA K. (UKR)	0
12	(*3) HUBRICH S. (GER)	0



1. SALAMA REEM AHMED (EGY)
2. GOMEZ MORALES NADIA (ESP)
3. ZHANGBYRBAY MOLDIR (KAZ)
3. SALAZAR YORGELIS (VEN)
5. TSANG YEE TING (HKG)
5. TSUTSUMI SARA (JPN)
7. KRYVA KATERYNA (UKR)
7. PALASHEVSKA YULIIA (UKR)

\*Seeded

Referees:			

# Female Kumite -50 Kg - Round Robin (each against each)

Karate1 Premier League - Fukuoka 2023, Fukuoka, JPN

Tatami

Pool  
3/6

1	(*22) ABZHANOVA M. (KAZ)	PTS	0	(*8) PALASHEVSKA Y. (UKR)
2	(*8) PALASHEVSKA Y. (UKR)	PTS	1	
3	(*22) ABZHANOVA M. (KAZ)	PTS	1	(*2) SALAMA R. (EGY)
4	(*2) SALAMA R. (EGY)	PTS	6	
5	(*8) PALASHEVSKA Y. (UKR)	PTS	1	(*2) SALAMA R. (EGY)
6	(*2) SALAMA R. (EGY)	PTS	3	



1. SALAMA REEM AHMED (EGY)
2. GOMEZ MORALES NADIA (ESP)
3. ZHANGBYRBAY MOLDIR (KAZ)
3. SALAZAR YORGELIS (VEN)
5. TSANG YEE TING (HKG)
5. TSUTSUMI SARA (JPN)
7. KRYVA KATERYNA (UKR)
7. PALASHEVSKA YULIIA (UKR)

\*Seeded

Referees:			



# Female Kumite -50 Kg - Round Robin (each against each)

Karate1 Premier League - Fukuoka 2023, Fukuoka, JPN

Tatami

Pool  
4/6

1	(*11) OUIKENE C. (ALG)	6	(*11) OUIKENE C. (ALG)
2	(*18) BUGUR S. (GER)	0	
3	(*17) TSUTSUMI S. (JPN)	4	(*17) TSUTSUMI S. (JPN)
4	(*5) ZHANGBYRBAY M. (KAZ)	3	
5	(*18) BUGUR S. (GER)	1	(*18) BUGUR S. (GER)
6	(*17) TSUTSUMI S. (JPN)	1	
7	(*11) OUIKENE C. (ALG)	0	(*5) ZHANGBYRBAY M. (KAZ)
8	(*5) ZHANGBYRBAY M. (KAZ)	1	
9	(*11) OUIKENE C. (ALG)	0	(*17) TSUTSUMI S. (JPN)
10	(*17) TSUTSUMI S. (JPN)	1	
11	(*18) BUGUR S. (GER)	2	(*5) ZHANGBYRBAY M. (KAZ)
12	(*5) ZHANGBYRBAY M. (KAZ)	8	



1. SALAMA REEM AHMED (EGY)
2. GOMEZ MORALES NADIA (ESP)
3. ZHANGBYRBAY MOLDIR (KAZ)
3. SALAZAR YORGELIS (VEN)
5. TSANG YEE TING (HKG)
5. TSUTSUMI SARA (JPN)
7. KRYVA KATERYNA (UKR)
7. PALASHEVSKA YULIIA (UKR)

\*Seeded

Referees:			

# Female Kumite -50 Kg - Round Robin (each against each)

Karate1 Premier League - Fukuoka 2023, Fukuoka, JPN

Tatami

Pool  
5/6

1	(*20) GOMEZ MORALES N. (ESP)	2	(*20) GOMEZ MORALES N. (ESP)
2	(*13) OKAZAKI A. (JPN)	1	
3	(*12) IZAGUIRRE G. (ESA)	2	
4	(*4) TSUKII J. (PHI)	2	
5	(*13) OKAZAKI A. (JPN)	3	(*13) OKAZAKI A. (JPN)
6	(*12) IZAGUIRRE G. (ESA)	1	
7	(*20) GOMEZ MORALES N. (ESP)	0	
8	(*4) TSUKII J. (PHI)	0	
9	(*20) GOMEZ MORALES N. (ESP)	10	(*20) GOMEZ MORALES N. (ESP)
10	(*12) IZAGUIRRE G. (ESA)	5	
11	(*13) OKAZAKI A. (JPN)	4	(*13) OKAZAKI A. (JPN)
12	(*4) TSUKII J. (PHI)	2	



1. SALAMA REEM AHMED (EGY)
2. GOMEZ MORALES NADIA (ESP)
3. ZHANGBYRBAY MOLDIR (KAZ)
3. SALAZAR YORGELIS (VEN)
5. TSANG YEE TING (HKG)
5. TSUTSUMI SARA (JPN)
7. KRYVA KATERYNA (UKR)
7. PALASHEVSKA YULIIA (UKR)

\*Seeded









Referees:			

# Female Kumite -50 Kg - Round Robin (each against each)

Karate1 Premier League - Fukuoka 2023, Fukuoka, JPN

Tatami

Pool  
6/6

1	 (*16) SEKKOUR R. (ALG)	5	 (*16) SEKKOUR R. (ALG)
2	 (*15) GU S. (TPE)	1	
3	 (*16) SEKKOUR R. (ALG)	0	 (*1) SALAZAR Y. (VEN)
4	 (*1) SALAZAR Y. (VEN)	5	
5	 (*15) GU S. (TPE)	4	 (*1) SALAZAR Y. (VEN)
6	 (*1) SALAZAR Y. (VEN)	7	



1. SALAMA REEM AHMED (EGY)
2. GOMEZ MORALES NADIA (ESP)
3. ZHANGBYRBAY MOLDIR (KAZ)
3. SALAZAR YORGELIS (VEN)
5. TSANG YEE TING (HKG)
5. TSUTSUMI SARA (JPN)
7. KRYVA KATERYNA (UKR)
7. PALASHEVSKA YULIIA (UKR)

\*Seeded

Referees:			

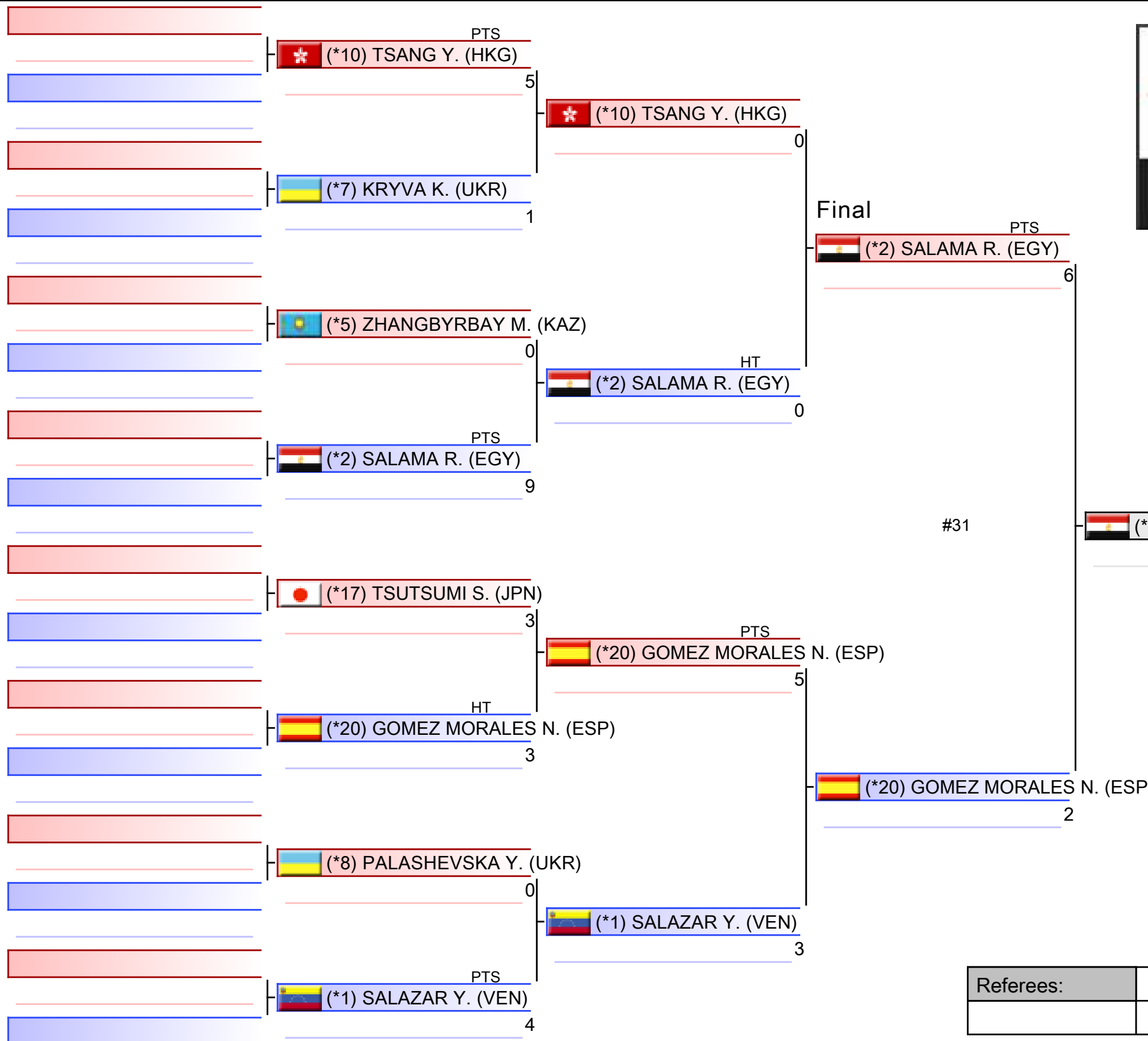

1. SALAMA REEM AHMED (EGY)
2. GOMEZ MORALES NADIA (ESP)
3. ZHANGBYRBAY MOLDIR (KAZ)
3. SALAZAR YORGELIS (VEN)
5. TSANG YEE TING (HKG)
5. TSUTSUMI SARA (JPN)
7. KRYVA KATERYNA (UKR)
7. PALASHEVSKA YULIIA (UKR)

\*Seeded

Referees:			

# Female Kumite -50 Kg

Karate1 Premier League - Fukuoka 2023

Tatami

Pool  
1,2,3,4,5,6

(c)sportdata GmbH & Co KG 2000-2023 (2023-06-11 18:09) v 10.0.1 build 1 (2023-05-19 20:00 CET) License: Online\_Event\_ID-705\_Karate1PremierLeagueFukuoka2023 (expire 2023-06-25)

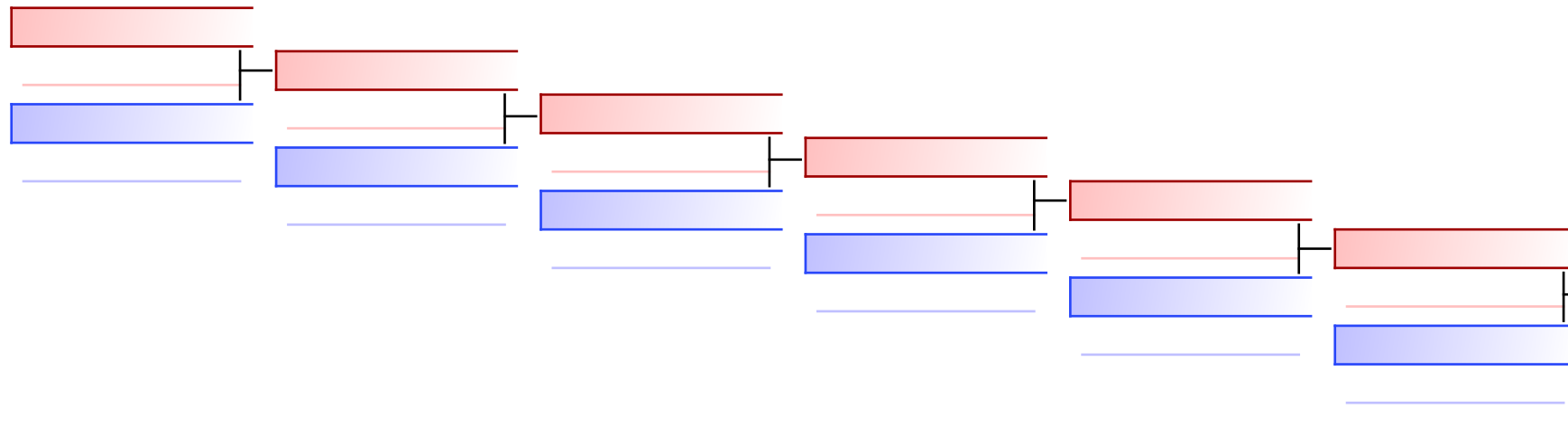

PTS	
2	ZHANGBYRBAY MOLDIR (KAZ)
1	TSANG YEE TING (HKG)

## REPECHAGE: (1,2,3,4,5,6)

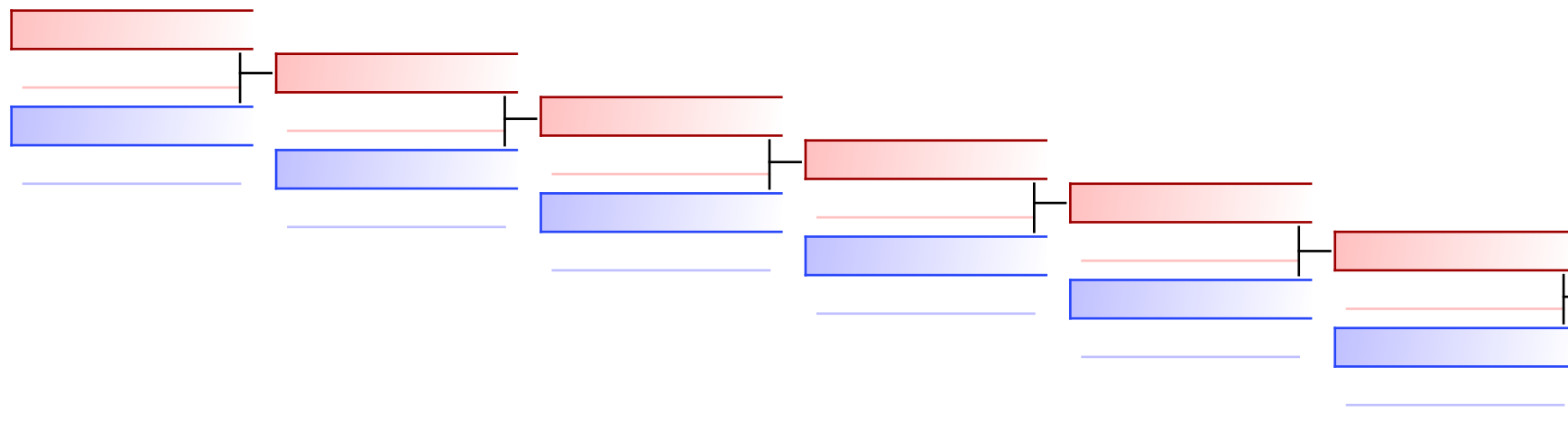

#6	
0	TSUTSUMI SARA (JPN)
8	salazar yorgelis (VEN)







Referees:							
-----------	--	--	--	--	--	--	--

# Female Kumite -55 Kg - Round Robin (each against each)

Karate1 Premier League - Fukuoka 2023, Fukuoka, JPN

Tatami

Pool  
1/8

1	 (*17) ZAREI L. (SWE)	
	PTS	2
2	 (*10) SCHAERER M. (SUI)	
	PTS	4
3	 (*17) ZAREI L. (SWE)	
	PTS	3
4	 (*6) ABOURICHE L. (ALG)	
	PTS	0
5	 (*10) SCHAERER M. (SUI)	
	SEN	1
6	 (*6) ABOURICHE L. (ALG)	
	PTS	1



1. TERLIUGA ANZHELIKA (UKR)
2. NAKAMURA SHIORI (JPN)
3. SCHAERER MAYA (SUI)
3. USSENOVA GULMIRA (KAZ)
5. BUGUR GIZEM (GER)
5. KU TSUI-PING (TPE)
7. ALLEN TRINITY (USA)
7. FURUMOTO-DESHAIES HANA (CAN)

\*Seeded

Referees:			

# Female Kumite -55 Kg - Round Robin (each against each)

Karate1 Premier League - Fukuoka 2023, Fukuoka, JPN

Tatami

Pool  
2/8

1	(*22) ABDUL JAMIL S. (MAS)	0	(*11) KAMENOVA I. (BUL)
	PTS		
2	(*11) KAMENOVA I. (BUL)	8	
3	(*22) ABDUL JAMIL S. (MAS)	0	(*3) NAKAMURA S. (JPN)
	PTS		
4	(*3) NAKAMURA S. (JPN)	2	
5	(*11) KAMENOVA I. (BUL)	0	(*3) NAKAMURA S. (JPN)
	PTS		
6	(*3) NAKAMURA S. (JPN)	2	



1. TERLIUGA ANZHELIKA (UKR)
2. NAKAMURA SHIORI (JPN)
3. SCHAERER MAYA (SUI)
3. USSENOVA GULMIRA (KAZ)
5. BUGUR GIZEM (GER)
5. KU TSUI-PING (TPE)
7. ALLEN TRINITY (USA)
7. FURUMOTO-DESHAIES HANA (CAN)

\*Seeded

Referees:			

# Female Kumite -55 Kg - Round Robin (each against each)

Karate1 Premier League - Fukuoka 2023, Fukuoka, JPN

Tatami

Pool  
3/8

1	(*21) BITSCH M. (GER)	0	(*16) AIRI S. (JPN)
	PTS		
2	(*16) AIRI S. (JPN)	1	
3	(*21) BITSCH M. (GER)	1	(*7) ALLEN T. (USA)
	PTS		
4	(*7) ALLEN T. (USA)	2	
5	(*16) AIRI S. (JPN)	4	(*7) ALLEN T. (USA)
	SEN		
6	(*7) ALLEN T. (USA)	4	



1. TERLIUGA ANZHELIKA (UKR)
2. NAKAMURA SHIORI (JPN)
3. SCHAERER MAYA (SUI)
3. USSENOVA GULMIRA (KAZ)
5. BUGUR GIZEM (GER)
5. KU TSUI-PING (TPE)
7. ALLEN TRINITY (USA)
7. FURUMOTO-DESHAIES HANA (CAN)

\*Seeded

Referees:			











# Female Kumite -55 Kg - Round Robin (each against each)

Karate1 Premier League - Fukuoka 2023, Fukuoka, JPN

Tatami

Pool  
4/8

1	 (*15) YATOJI A. (JPN)	PTS	2	 (*15) YATOJI A. (JPN)
2	 (*9) SAMASHEVA B. (KAZ)	1		
3	 (*15) YATOJI A. (JPN)	PTS	0	 (*2) BUGUR G. (GER)
4	 (*2) BUGUR G. (GER)	3		
5	 (*9) SAMASHEVA B. (KAZ)	PTS	0	 (*2) BUGUR G. (GER)
6	 (*2) BUGUR G. (GER)	6		



1. TERLIUGA ANZHELIKA (UKR)
2. NAKAMURA SHIORI (JPN)
3. SCHAERER MAYA (SUI)
3. USSENOVA GULMIRA (KAZ)
5. BUGUR GIZEM (GER)
5. KU TSUI-PING (TPE)
7. ALLEN TRINITY (USA)
7. FURUMOTO-DESHAIES HANA (CAN)

\*Seeded









Referees:			

# Female Kumite -55 Kg - Round Robin (each against each)

Karate1 Premier League - Fukuoka 2023, Fukuoka, JPN

Tatami

Pool  
5/8

1	 (*20) HASANI A. (CRO)	
	PTS	1    (*14) KU T. (TPE)
2	 (*14) KU T. (TPE)	4
	PTS	
3	 (*20) HASANI A. (CRO)	2    (*20) HASANI A. (CRO)
4	 (*5) ERDAULET A. (KAZ)	0
	PTS	
5	 (*14) KU T. (TPE)	2    (*14) KU T. (TPE)
6	 (*5) ERDAULET A. (KAZ)	0
	PTS	



1. TERLIUGA ANZHELIKA (UKR)
2. NAKAMURA SHIORI (JPN)
3. SCHAEERER MAYA (SUI)
3. USSENOVA GULMIRA (KAZ)
5. BUGUR GIZEM (GER)
5. KU TSUI-PING (TPE)
7. ALLEN TRINITY (USA)
7. FURUMOTO-DESHAIES HANA (CAN)

\*Seeded









Referees:			

# Female Kumite -55 Kg - Round Robin (each against each)

Karate1 Premier League - Fukuoka 2023, Fukuoka, JPN

Tatami

Pool  
6/8

1	 (*19) AGUNG SANISTYARANI C. (INA)	2	 (*19) AGUNG SANISTYARANI C. (INA)
2	 (*18) LORENZO COUSO R. (ESP)	0	
3	 (*19) AGUNG SANISTYARANI C. (INA)	6	 (*4) FURUMOTO-DESHAIES H. (CAN)
4	 (*4) FURUMOTO-DESHAIES H. (CAN)	7	
5	 (*18) LORENZO COUSO R. (ESP)	1	 (*4) FURUMOTO-DESHAIES H. (CAN)
6	 (*4) FURUMOTO-DESHAIES H. (CAN)	4	



1. TERLIUGA ANZHELIKA (UKR)
2. NAKAMURA SHIORI (JPN)
3. SCHAERER MAYA (SUI)
3. USSENOVA GULMIRA (KAZ)
5. BUGUR GIZEM (GER)
5. KU TSUI-PING (TPE)
7. ALLEN TRINITY (USA)
7. FURUMOTO-DESHAIES HANA (CAN)

\*Seeded









Referees:			

# Female Kumite -55 Kg - Round Robin (each against each)

Karate1 Premier League - Fukuoka 2023, Fukuoka, JPN

Tatami

Pool  
7/8

1	 (*13) USSENOVA G. (KAZ)	2	 (*13) USSENOVA G. (KAZ)
2	 (*23) POOVANESAN M. (MAS)	1	
	PTS		
3	 (*13) USSENOVA G. (KAZ)	3	 (*13) USSENOVA G. (KAZ)
4	 (*8) TORO MENESES V. (CHI)	0	
5	 (*23) POOVANESAN M. (MAS)	6	 (*8) TORO MENESES V. (CHI)
	PTS		
6	 (*8) TORO MENESES V. (CHI)	9	



1. TERLIUGA ANZHELIKA (UKR)
2. NAKAMURA SHIORI (JPN)
3. SCHAERER MAYA (SUI)
3. USSENOVA GULMIRA (KAZ)
5. BUGUR GIZEM (GER)
5. KU TSUI-PING (TPE)
7. ALLEN TRINITY (USA)
7. FURUMOTO-DESHAIES HANA (CAN)

\*Seeded









Referees:			

# Female Kumite -55 Kg - Round Robin (each against each)

Karate1 Premier League - Fukuoka 2023, Fukuoka, JPN

Tatami

Pool  
8/8

1	 (*12) KUKLOVA H. (SVK)	2	 (*24) ROSENLIND M. (SWE)
	PTS		
2	 (*24) ROSENLIND M. (SWE)		11
3	 (*12) KUKLOVA H. (SVK)	1	 (*1) TERLIUGA A. (UKR)
	PTS		
4	 (*1) TERLIUGA A. (UKR)		5
5	 (*24) ROSENLIND M. (SWE)	5	 (*1) TERLIUGA A. (UKR)
	PTS		
6	 (*1) TERLIUGA A. (UKR)		10



1. TERLIUGA ANZHELIKA (UKR)
2. NAKAMURA SHIORI (JPN)
3. SCHAERER MAYA (SUI)
3. USSENOVA GULMIRA (KAZ)
5. BUGUR GIZEM (GER)
5. KU TSUI-PING (TPE)
7. ALLEN TRINITY (USA)
7. FURUMOTO-DESHAIES HANA (CAN)

\*Seeded

Referees:			

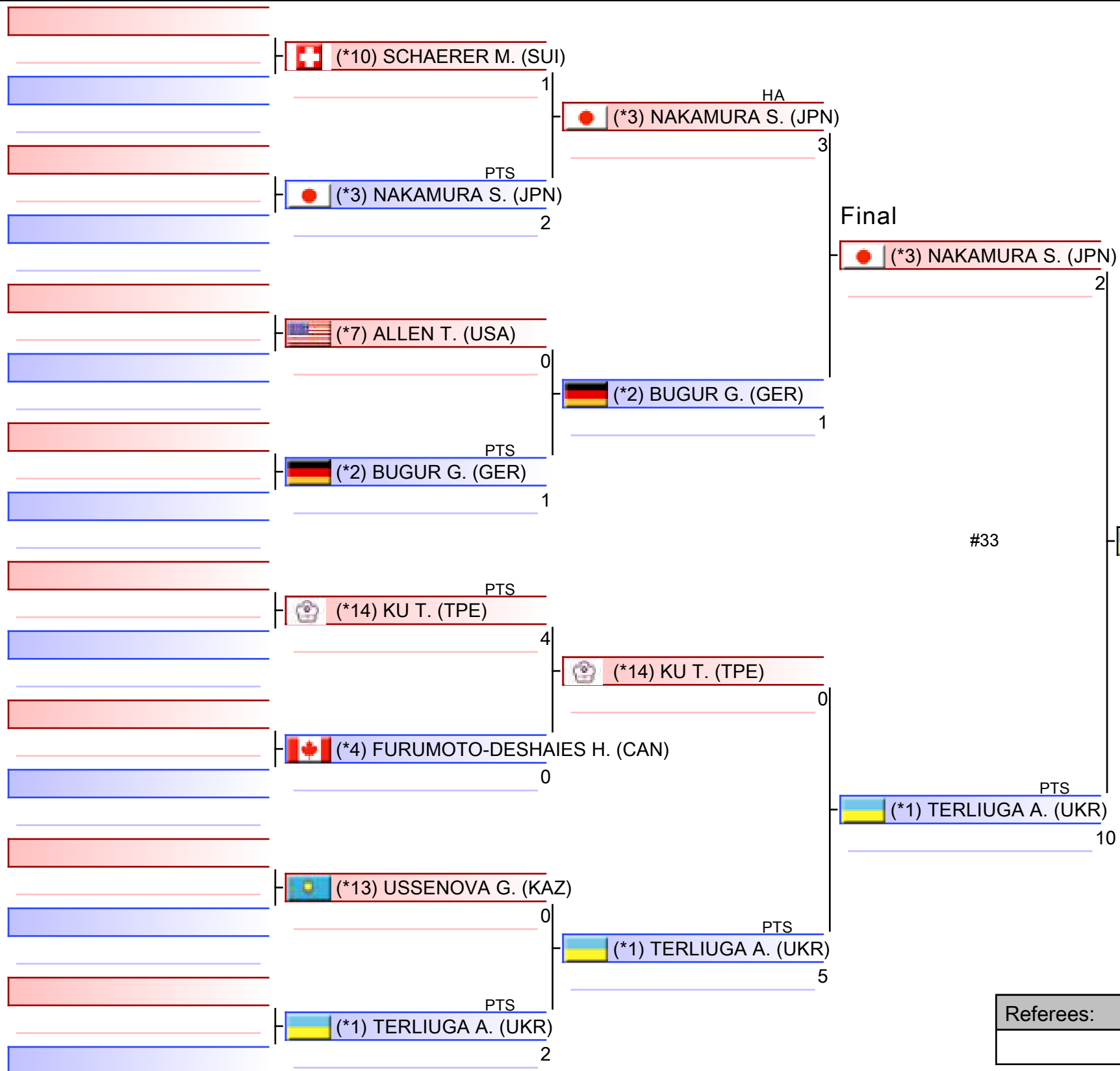

1. TERLIUGA ANZHELIKA (UKR)
2. NAKAMURA SHIORI (JPN)
3. SCHAERER MAYA (SUI)
3. USSENOVA GULMIRA (KAZ)
5. BUGUR GIZEM (GER)
5. KU TSUI-PING (TPE)
7. ALLEN TRINITY (USA)
7. FURUMOTO-DESHAIES HANA (CAN)

\*Seeded

Referees:			

# Female Kumite -55 Kg

Karate1 Premier League - Fukuoka 2023

Tatami

Pool

1,2,3,4,5,6,7,8

(c)sportdata GmbH & Co KG 2000-2023 (2023-06-11 18:09) v 10.0.1 build 1 (2023-05-19 20:00 CET) License: Online\_Event\_ID-705\_Karate1PremierLeagueFukuoka2023 (expire 2023-06-25)

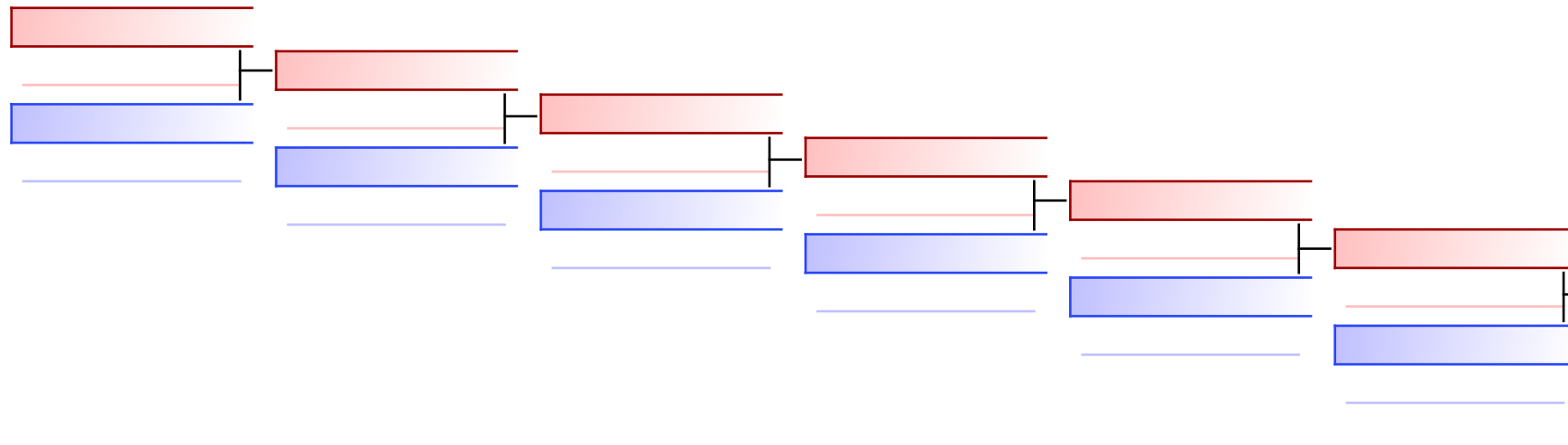

#9

PTS

SCHAERER MAYA (SUI) | 1

BUGUR GIZEM (GER) | 0

## REPECHAGE: (1,2,3,4,5,6,7,8)

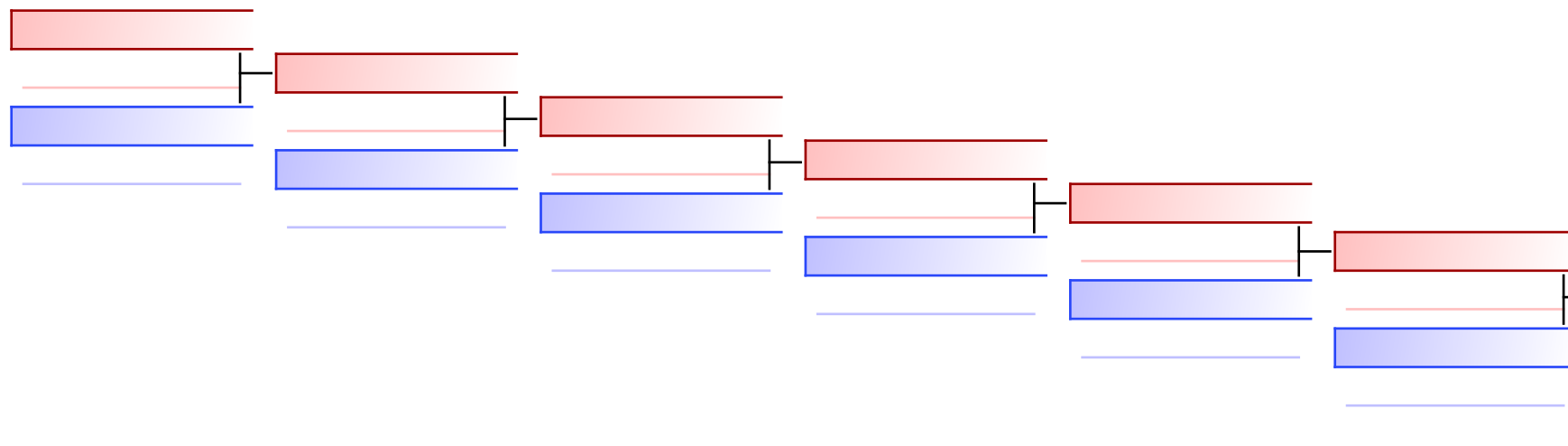

#10

SEN

USSENOVA GULMIRA (KAZ) | 4

KU TSUI-PING (TPE) | 4



















Referees:							
-----------	--	--	--	--	--	--	--

# Female Kumite -61 Kg - Round Robin (each against each)

Karate1 Premier League - Fukuoka 2023, Fukuoka, JPN

Tatami

Pool  
1/4

1	 (*6) CHRYSOPOULOU K. (GRE)	
	#194 PTS	1    (*12) SHIMADA S. (JPN)
2	 (*12) SHIMADA S. (JPN)	2
3	 (*11) MALAUTA M. (ROU)	
	#195 PTS	0    (*3) KANAY A. (KAZ)
4	 (*3) KANAY A. (KAZ)	1
	PTS	
5	 (*12) SHIMADA S. (JPN)	
	#196	3    (*12) SHIMADA S. (JPN)
6	 (*11) MALAUTA M. (ROU)	1
7	 (*6) CHRYSOPOULOU K. (GRE)	
	#197 PTS	0    (*3) KANAY A. (KAZ)
8	 (*3) KANAY A. (KAZ)	9
9	 (*6) CHRYSOPOULOU K. (GRE)	
	#198 PTS	4    (*11) MALAUTA M. (ROU)
10	 (*11) MALAUTA M. (ROU)	6
11	 (*12) SHIMADA S. (JPN)	
	#199 PTS	2    (*3) KANAY A. (KAZ)
12	 (*3) KANAY A. (KAZ)	3



1. SHIMADA SARARA (JPN)
2. KHAMIS REEM (GER)
3. SEROGINA ANITA (UKR)
3. KUJURO YUKI (JPN)
5. NILSSON ANNA-JOHANNA (SWE)
5. SUZUKI MAYA (JPN)
7. KANAY ASSEL (KAZ)
7. FACTOS JACQUELIN (ECU)

\*Seeded

Referees:			



# Female Kumite -61 Kg - Round Robin (each against each)

Karate1 Premier League - Fukuoka 2023, Fukuoka, JPN

Tatami

Pool  
2/4

1	(*8) RADJENOVIC N. (SUI)	
	#236 PTS	3    (*13) FERNANDEZ OSORIO C. (ESP)
2	(*13) FERNANDEZ OSORIO C. (ESP)	4
3	(*7) FACTOS J. (ECU)	
	#237 PTS	4    (*2) KHAMIS R. (GER)
4	(*2) KHAMIS R. (GER)	5
5	(*13) FERNANDEZ OSORIO C. (ESP)	0
6	(*7) FACTOS J. (ECU)	0
7	(*8) RADJENOVIC N. (SUI)	
	#239 PTS	2    (*2) KHAMIS R. (GER)
8	(*2) KHAMIS R. (GER)	3
9	(*8) RADJENOVIC N. (SUI)	
	#240 PTS	7    (*7) FACTOS J. (ECU)
10	(*7) FACTOS J. (ECU)	8
11	(*13) FERNANDEZ OSORIO C. (ESP)	
	#241 PTS	1    (*2) KHAMIS R. (GER)
12	(*2) KHAMIS R. (GER)	2



1. SHIMADA SARARA (JPN)
2. KHAMIS REEM (GER)
3. SEROGINA ANITA (UKR)
3. KUJURO YUKI (JPN)
5. NILSSON ANNA-JOHANNA (SWE)
5. SUZUKI MAYA (JPN)
7. KANAY ASSEL (KAZ)
7. FACTOS JACQUELIN (ECU)

\*Seeded

Referees:			

# Female Kumite -61 Kg - Round Robin (each against each)

Karate1 Premier League - Fukuoka 2023, Fukuoka, JPN

Tatami

Pool  
3/4

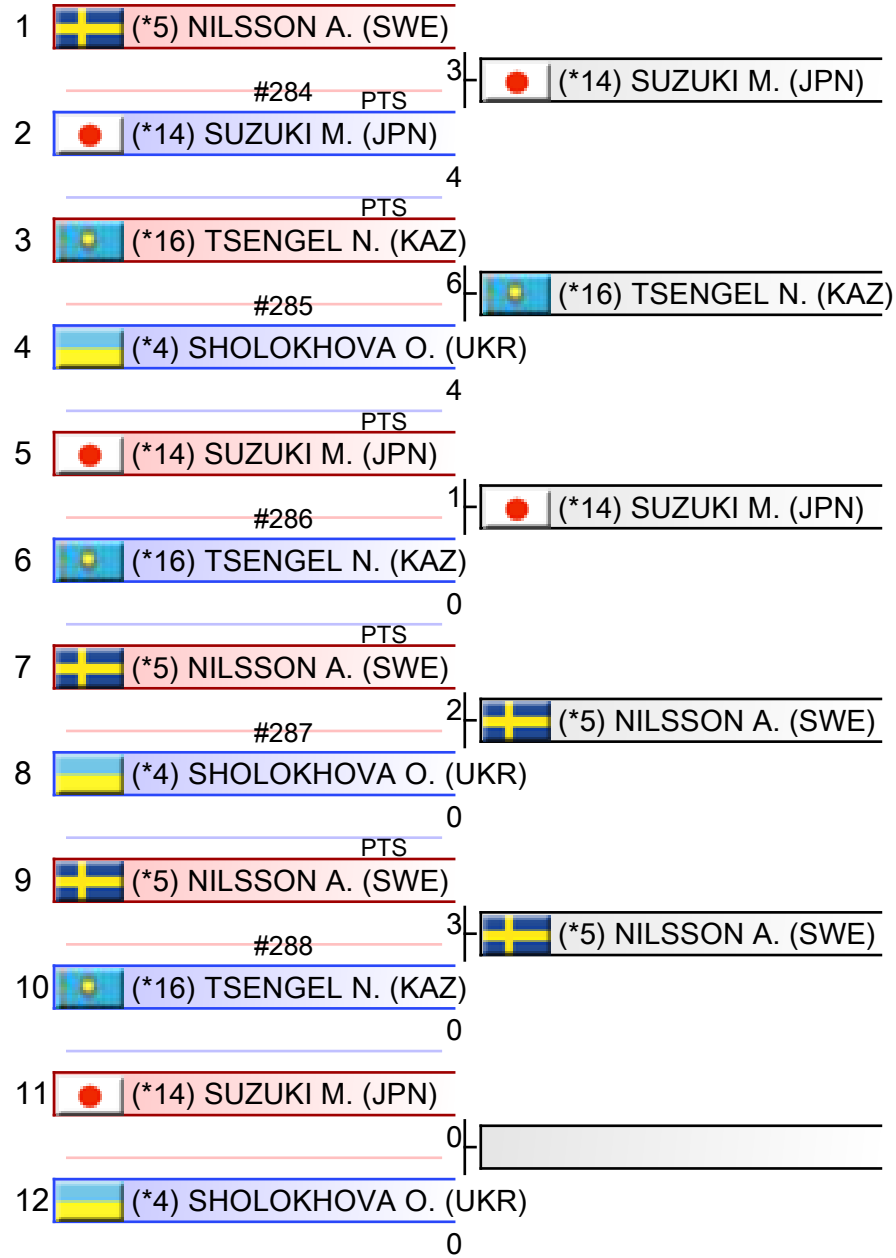

1. SHIMADA SARARA (JPN)
2. KHAMIS REEM (GER)
3. SEROGINA ANITA (UKR)
3. KUJURO YUKI (JPN)
5. NILSSON ANNA-JOHANNA (SWE)
5. SUZUKI MAYA (JPN)
7. KANAY ASSEL (KAZ)
7. FACTOS JACQUELIN (ECU)

\*Seeded

Referees:			

# Female Kumite -61 Kg - Round Robin (each against each)

Karate1 Premier League - Fukuoka 2023, Fukuoka, JPN

Tatami

Pool  
4/4

1	(*10) GRANDE A. (PER)	3	(*10) GRANDE A. (PER)
	#323		
2	(*15) TOPALOVIC L. (AUT)	2	
3	(*9) KUJURO Y. (JPN)	1	
4	(*1) SEROGINA A. (UKR)	1	
5	(*15) TOPALOVIC L. (AUT)	0	(*9) KUJURO Y. (JPN)
	#325 PTS		
6	(*9) KUJURO Y. (JPN)	2	
7	(*10) GRANDE A. (PER)	0	
8	(*1) SEROGINA A. (UKR)	0	
9	(*10) GRANDE A. (PER)	0	(*9) KUJURO Y. (JPN)
	#327 PTS		
10	(*9) KUJURO Y. (JPN)	1	
11	(*15) TOPALOVIC L. (AUT)	0	(*1) SEROGINA A. (UKR)
	#328 PTS		
12	(*1) SEROGINA A. (UKR)	4	



1. SHIMADA SARARA (JPN)
2. KHAMIS REEM (GER)
3. SEROGINA ANITA (UKR)
3. KUJURO YUKI (JPN)
5. NILSSON ANNA-JOHANNA (SWE)
5. SUZUKI MAYA (JPN)
7. KANAY ASSEL (KAZ)
7. FACTOS JACQUELIN (ECU)

\*Seeded

Referees:			

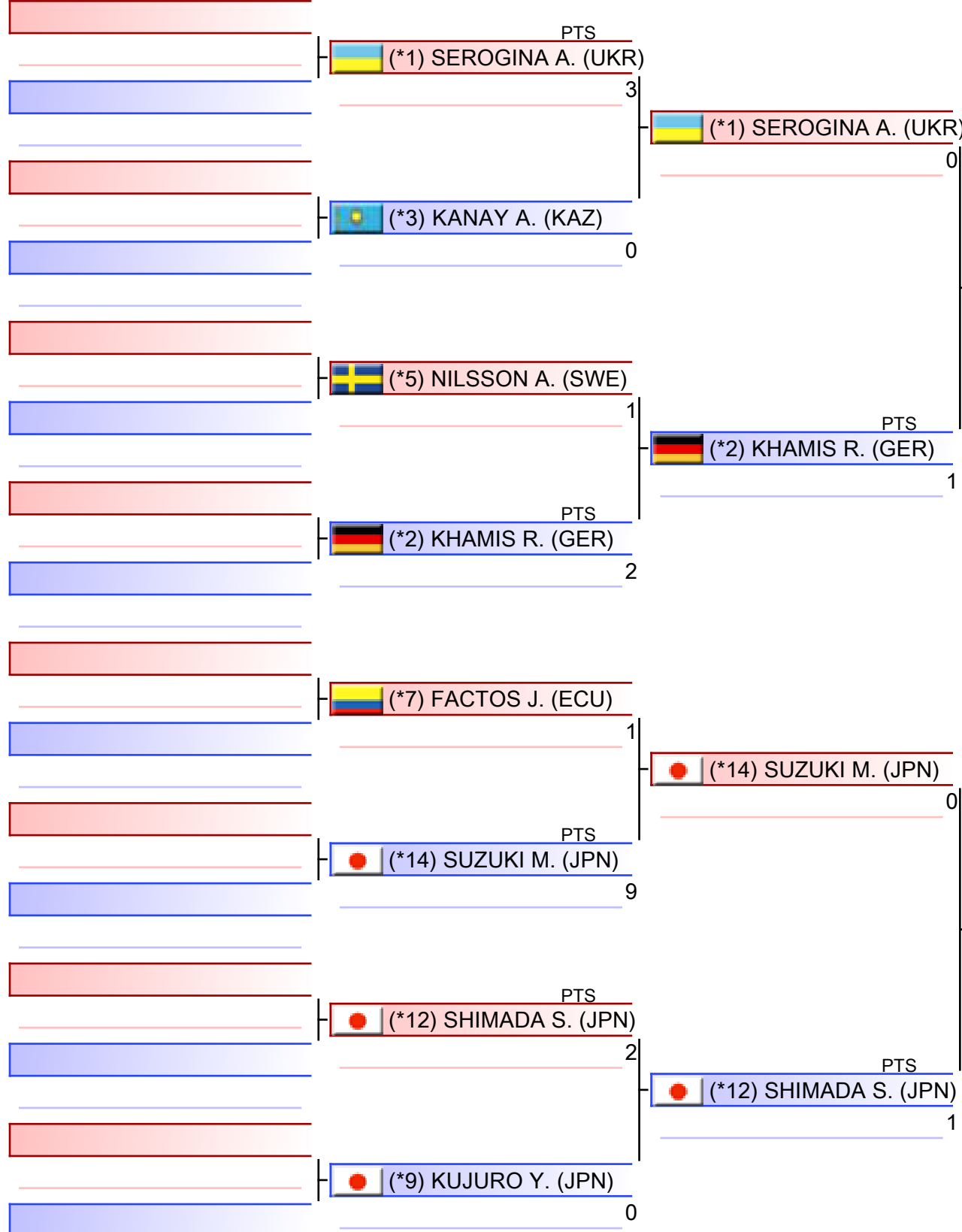

Final

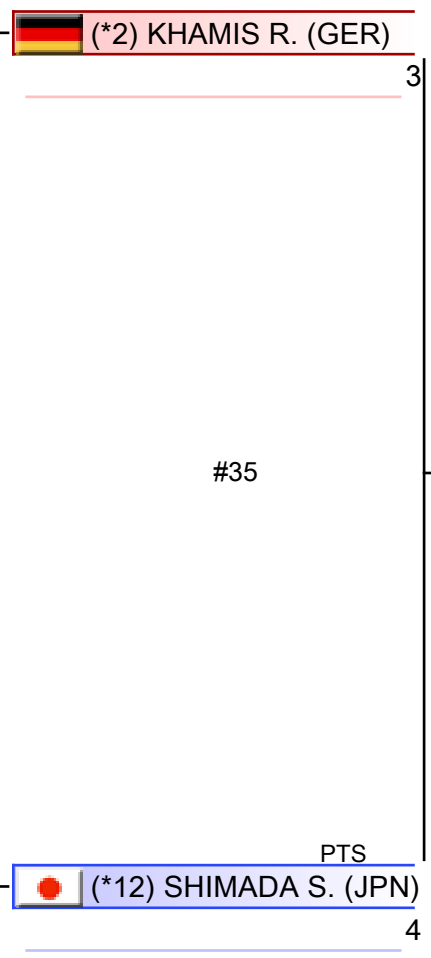

#35

(\*12) SHIMADA S. (JPN)

1. SHIMADA SARARA (JPN)
2. KHAMIS REEM (GER)
3. SEROGINA ANITA (UKR)
3. KUJURO YUKI (JPN)
5. NILSSON ANNA-JOHANNA (SWE)
5. SUZUKI MAYA (JPN)
7. KANAY ASSEL (KAZ)
7. FACTOS JACQUELIN (ECU)

\*Seeded

Referees:			

# Female Kumite -61 Kg

Karate1 Premier League - Fukuoka 2023

Tatami

Pool  
1,2,3,4

(c)sportdata GmbH & Co KG 2000-2023 (2023-06-11 18:09) v 10.0.1 build 1 (2023-05-19 20:00 CET) License: Online\_Event\_ID-705\_Karate1PremierLeagueFukuoka2023 (expire 2023-06-25)

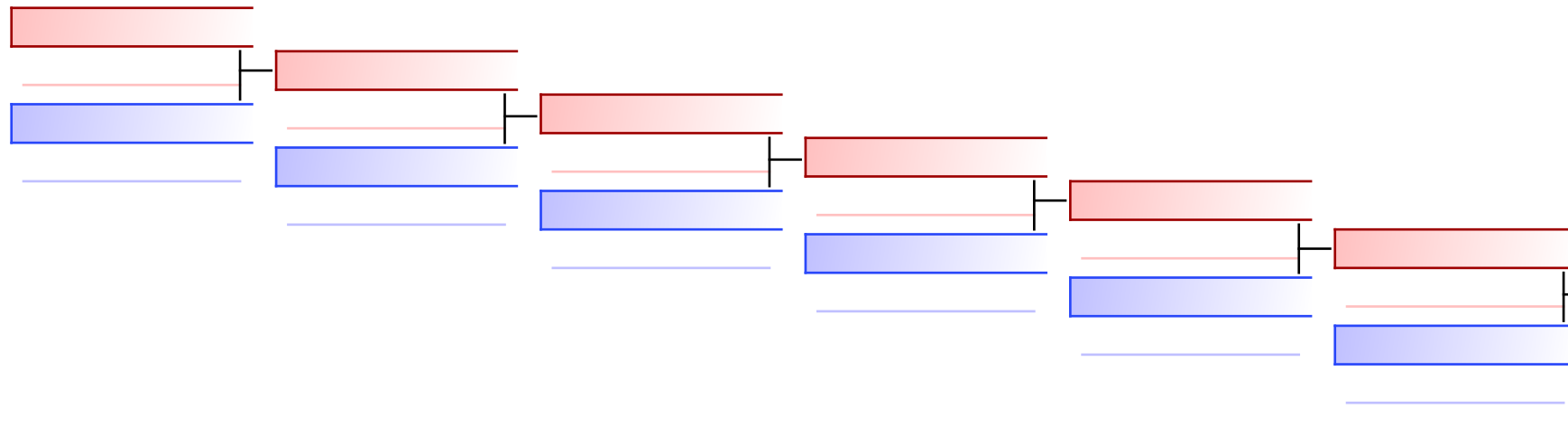

#13  
PTS  
NILSSON ANNA-JOHANNA (SWE) 0  
SEROGINA ANITA (UKR) 1

## REPECHAGE: (1,2,3,4)

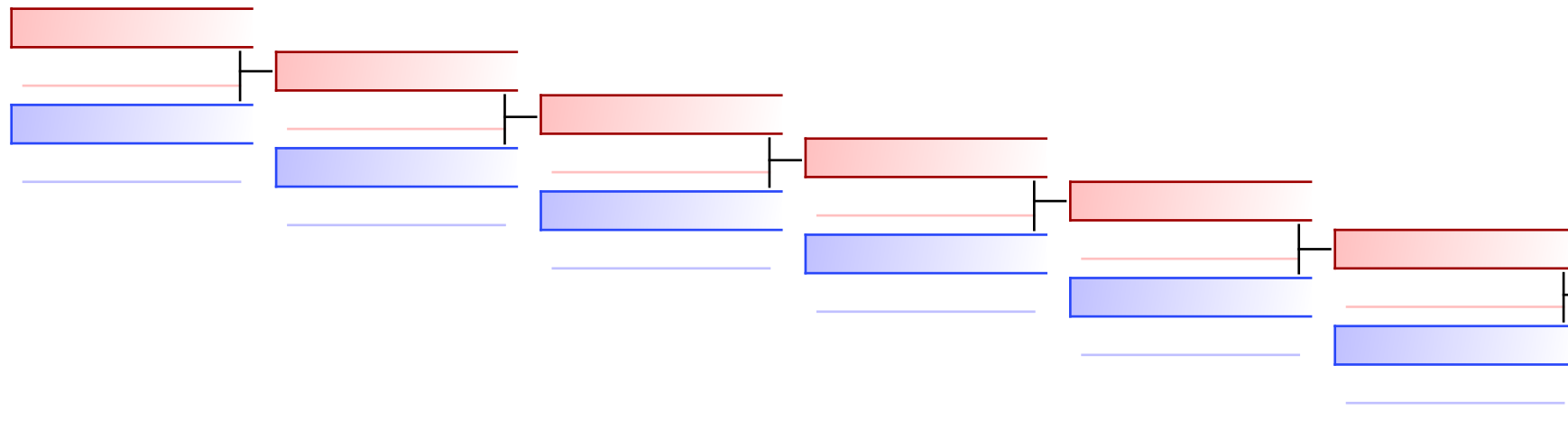

#14  
PTS  
KUJURO YUKI (JPN) 5  
SUZUKI MAYA (JPN) 4

Referees:							
-----------	--	--	--	--	--	--	--

# Female Kumite -68 Kg - Round Robin (each against each)

Karate1 Premier League - Fukuoka 2023, Fukuoka, JPN

Tatami

Pool  
1/6

1	(*14) NIETO MEJIAS M. (ESP)	7	(*14) NIETO MEJIAS M. (ESP)
	#251		
2	(*15) DEUBLE S. (SUI)	0	
3	(*17) JADHAV B. (IND)	0	(*6) RIEDEL H. (GER)
	#252 PTS		
4	(*6) RIEDEL H. (GER)	1	
5	(*15) DEUBLE S. (SUI)	0	
6	(*17) JADHAV B. (IND)	0	
7	(*14) NIETO MEJIAS M. (ESP)	3	(*6) RIEDEL H. (GER)
	#255 SEN		
8	(*6) RIEDEL H. (GER)	3	
	PTS		
9	(*14) NIETO MEJIAS M. (ESP)	5	(*14) NIETO MEJIAS M. (ESP)
	#257		
10	(*17) JADHAV B. (IND)	0	
11	(*15) DEUBLE S. (SUI)	0	(*6) RIEDEL H. (GER)
	#258 PTS		
12	(*6) RIEDEL H. (GER)	1	



1. QUIRICI ELENA (SUI)
2. KAMA TSUBASA (JPN)
3. ALIKUL LAURA (KAZ)
3. ZARETSKA IRYNA (AZE)
5. SOMEYA KAYO (JPN)
5. ZHAXYBAYEVA VENERA (KAZ)
7. RIEDEL HANNAH (GER)
7. SCHROETER MADELEINE (GER)

\*Seeded

Referees:			

# Female Kumite -68 Kg - Round Robin (each against each)

Karate1 Premier League - Fukuoka 2023, Fukuoka, JPN

Tatami

Pool  
2/6

1	(*18) GONG L. (CHN)	0	(*22) KRIVDOVA S. (SVK)
	#206 PTS		
2	(*22) KRIVDOVA S. (SVK)	1	
3	(*20) ZHAXYBAYEVA V. (KAZ)	0	
4	(*3) MELNYK H. (UKR)	0	
5	(*22) KRIVDOVA S. (SVK)	0	(*20) ZHAXYBAYEVA V. (KAZ)
	#208 PTS		
6	(*20) ZHAXYBAYEVA V. (KAZ)	3	
	PTS		
7	(*18) GONG L. (CHN)	7	(*18) GONG L. (CHN)
	#209		
8	(*3) MELNYK H. (UKR)	0	
9	(*18) GONG L. (CHN)	0	(*20) ZHAXYBAYEVA V. (KAZ)
	#210 PTS		
10	(*20) ZHAXYBAYEVA V. (KAZ)	3	
	PTS		
11	(*22) KRIVDOVA S. (SVK)	1	(*22) KRIVDOVA S. (SVK)
	#211		
12	(*3) MELNYK H. (UKR)	0	



1. QUIRICI ELENA (SUI)
2. KAMA TSUBASA (JPN)
3. ALIKUL LAURA (KAZ)
3. ZARETSKA IRYNA (AZE)
5. SOMEYA KAYO (JPN)
5. ZHAXYBAYEVA VENERA (KAZ)
7. RIEDEL HANNAH (GER)
7. SCHROETER MADELEINE (GER)

\*Seeded

Referees:			

# Female Kumite -68 Kg - Round Robin (each against each)

Karate1 Premier League - Fukuoka 2023, Fukuoka, JPN

Tatami

Pool  
3/6

1	(*8) SCHROETER M. (GER)	1	(*8) SCHROETER M. (GER)
	#253		
2	(*13) BECIROVIC S. (CRO)	0	
3	(*8) SCHROETER M. (GER)	0	(*2) QUIRICI E. (SUI)
	#259 PTS		
4	(*2) QUIRICI E. (SUI)	4	
5	(*13) BECIROVIC S. (CRO)	0	(*2) QUIRICI E. (SUI)
	#256 PTS		
6	(*2) QUIRICI E. (SUI)	1	



1. QUIRICI ELENA (SUI)
2. KAMA TSUBASA (JPN)
3. ALIKUL LAURA (KAZ)
3. ZARETSKA IRYNA (AZE)
5. SOMEYA KAYO (JPN)
5. ZHAXYBAYEVA VENERA (KAZ)
7. RIEDEL HANNAH (GER)
7. SCHROETER MADELEINE (GER)

\*Seeded

Referees:			



# Female Kumite -68 Kg - Round Robin (each against each)

Karate1 Premier League - Fukuoka 2023, Fukuoka, JPN

Tatami

Pool  
4/6

1	(*11) KAMA T. (JPN)		
	#338	8	(*11) KAMA T. (JPN)
2	(*19) LI Q. (CHN)		
		5	
3	(*12) YAP M. (AUS)		
	#339	1	(*5) ELTEMUR E. (TUR)
4	(*5) ELTEMUR E. (TUR)		
		5	
		PTS	
5	(*19) LI Q. (CHN)		
	#341	3	(*19) LI Q. (CHN)
6	(*12) YAP M. (AUS)		
		1	
		PTS	
7	(*11) KAMA T. (JPN)		
	#342	6	(*11) KAMA T. (JPN)
8	(*5) ELTEMUR E. (TUR)		
		2	
		PTS	
9	(*11) KAMA T. (JPN)		
	#344	7	(*11) KAMA T. (JPN)
10	(*12) YAP M. (AUS)		
		0	
		PTS	
11	(*19) LI Q. (CHN)		
	#345	4	(*19) LI Q. (CHN)
12	(*5) ELTEMUR E. (TUR)		
		3	



1. QUIRICI ELENA (SUI)
2. KAMA TSUBASA (JPN)
3. ALIKUL LAURA (KAZ)
3. ZARETSKA IRYNA (AZE)
5. SOMEYA KAYO (JPN)
5. ZHAXYBAYEVA VENERA (KAZ)
7. RIEDEL HANNAH (GER)
7. SCHROETER MADELEINE (GER)

\*Seeded

Referees:			

# Female Kumite -68 Kg - Round Robin (each against each)

Karate1 Premier League - Fukuoka 2023, Fukuoka, JPN

Tatami

Pool  
5/6

1	(*10) WONG C. (HKG)		
	#296	4	(*10) WONG C. (HKG)
2	(*16) CHAO J. (TPE)		
		4	
3	(*9) ELMEDANY O. (EGY)		
	#297 PTS	1	(*4) SOMEYA K. (JPN)
4	(*4) SOMEYA K. (JPN)		
		4	
5	(*16) CHAO J. (TPE)		
	#298 PTS	1	(*16) CHAO J. (TPE)
6	(*9) ELMEDANY O. (EGY)		
		2	
7	(*10) WONG C. (HKG)		
	#299 PTS	0	(*4) SOMEYA K. (JPN)
8	(*4) SOMEYA K. (JPN)		
		1	
	PTS		
9	(*10) WONG C. (HKG)		
	#300	3	(*10) WONG C. (HKG)
10	(*9) ELMEDANY O. (EGY)		
		0	
11	(*16) CHAO J. (TPE)		
	#301 PTS	0	(*4) SOMEYA K. (JPN)
12	(*4) SOMEYA K. (JPN)		
		4	



1. QUIRICI ELENA (SUI)
2. KAMA TSUBASA (JPN)
3. ALIKUL LAURA (KAZ)
3. ZARETSKA IRYNA (AZE)
5. SOMEYA KAYO (JPN)
5. ZHAXYBAYEVA VENERA (KAZ)
7. RIEDEL HANNAH (GER)
7. SCHROETER MADELEINE (GER)

\*Seeded

Referees:			

# Female Kumite -68 Kg - Round Robin (each against each)

Karate1 Premier League - Fukuoka 2023, Fukuoka, JPN

Tatami

Pool  
6/6

1	(*21) YATOJI A. (JPN)	
	#340 PTS	0
2	(*7) ALIKUL L. (KAZ)	
	PTS	6
3	(*21) YATOJI A. (JPN)	
	#346	1
4	(*1) ZARETSKA I. (AZE)	
		0
5	(*7) ALIKUL L. (KAZ)	
	#343 PTS	4
6	(*1) ZARETSKA I. (AZE)	
		8



1. QUIRICI ELENA (SUI)
2. KAMA TSUBASA (JPN)
3. ALIKUL LAURA (KAZ)
3. ZARETSKA IRYNA (AZE)
5. SOMEYA KAYO (JPN)
5. ZHAXYBAYEVA VENERA (KAZ)
7. RIEDEL HANNAH (GER)
7. SCHROETER MADELEINE (GER)

\*Seeded

Referees:			

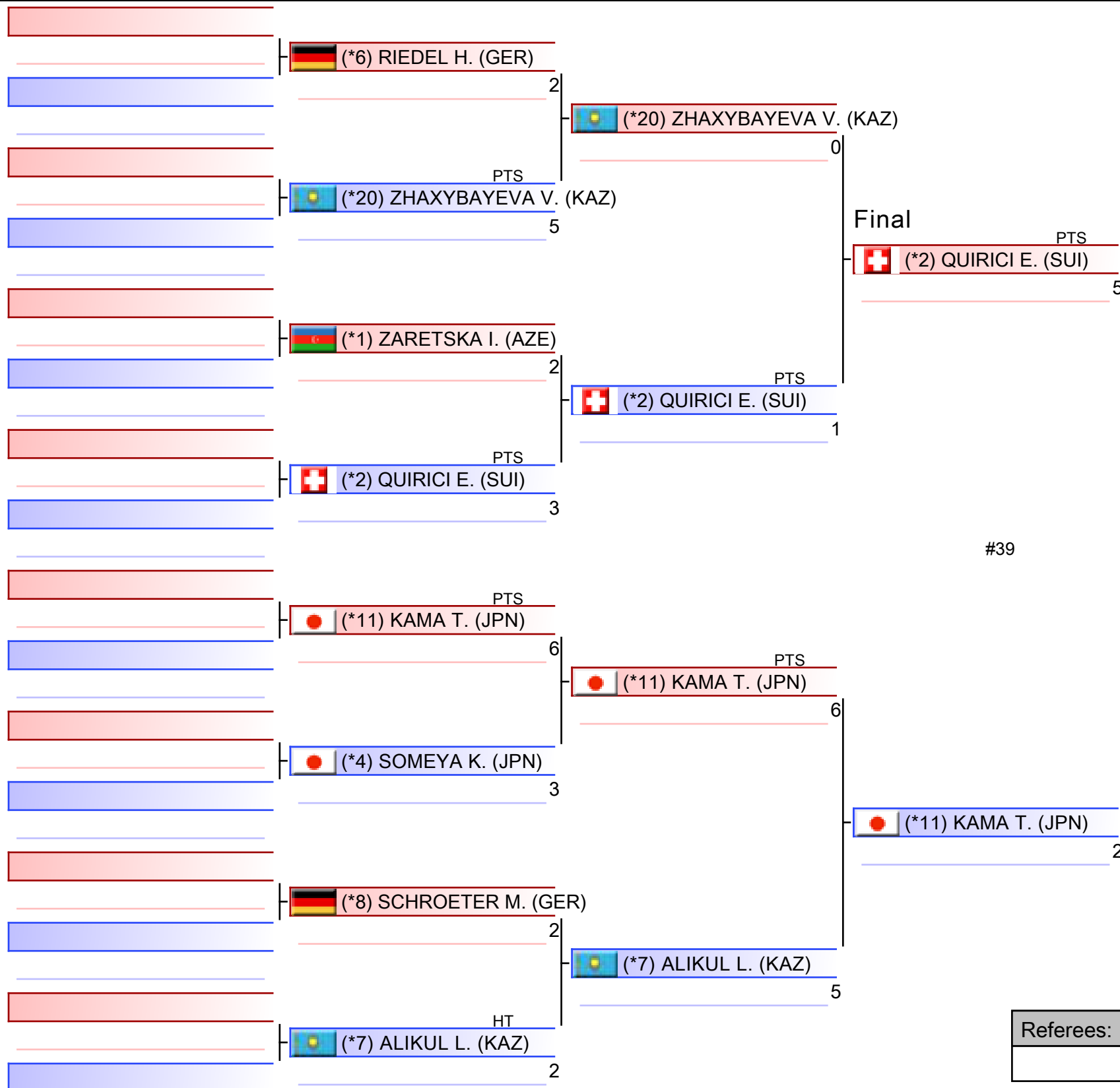

1. QUIRICI ELENA (SUI)
2. KAMA TSUBASA (JPN)
3. ALIKUL LAURA (KAZ)
3. ZARETSKA IRYNA (AZE)
5. SOMEYA KAYO (JPN)
5. ZHAXYBAYEVA VENERA (KAZ)
7. RIEDEL HANNAH (GER)
7. SCHROETER MADELEINE (GER)

\*Seeded

Referees:			

# Female Kumite -68 Kg

Karate1 Premier League - Fukuoka 2023

Tatami

Pool  
1,2,3,4,5,6

(c)sportdata GmbH & Co KG 2000-2023 (2023-06-11 18:09) v 10.0.1 build 1 (2023-05-19 20:00 CET) License: Online\_Event\_ID-705\_Karate1PremierLeagueFukuoka2023 (expire 2023-06-25)

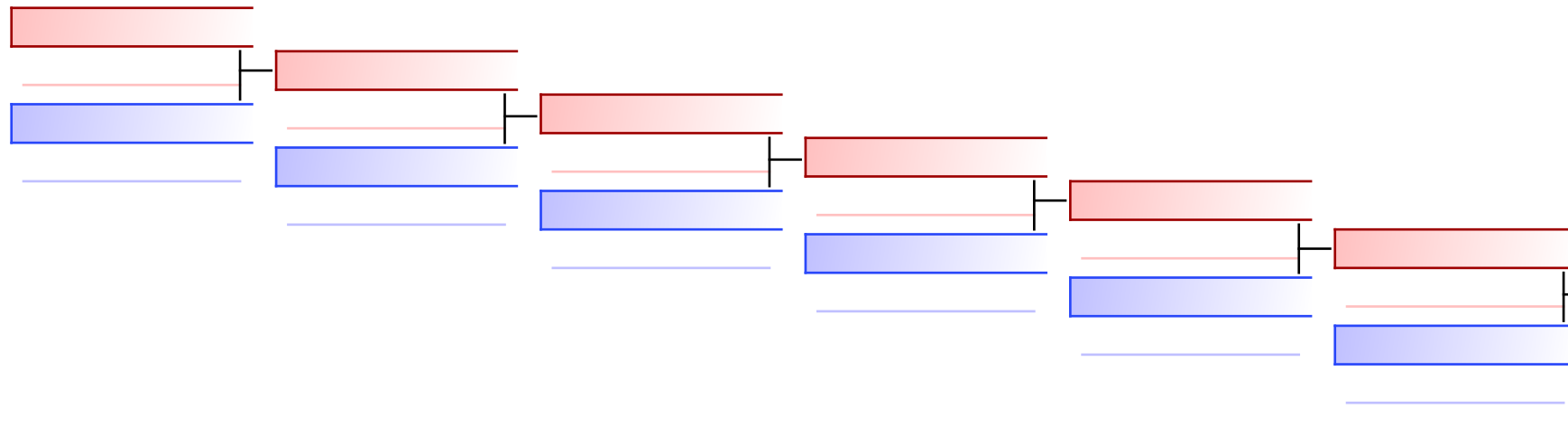

#22  
PTS  
ZARETSKA IRYNA (AZE) 9  
Zhaxybayeva Venera (KAZ) 0

## REPECHAGE: (1,2,3,4,5,6)

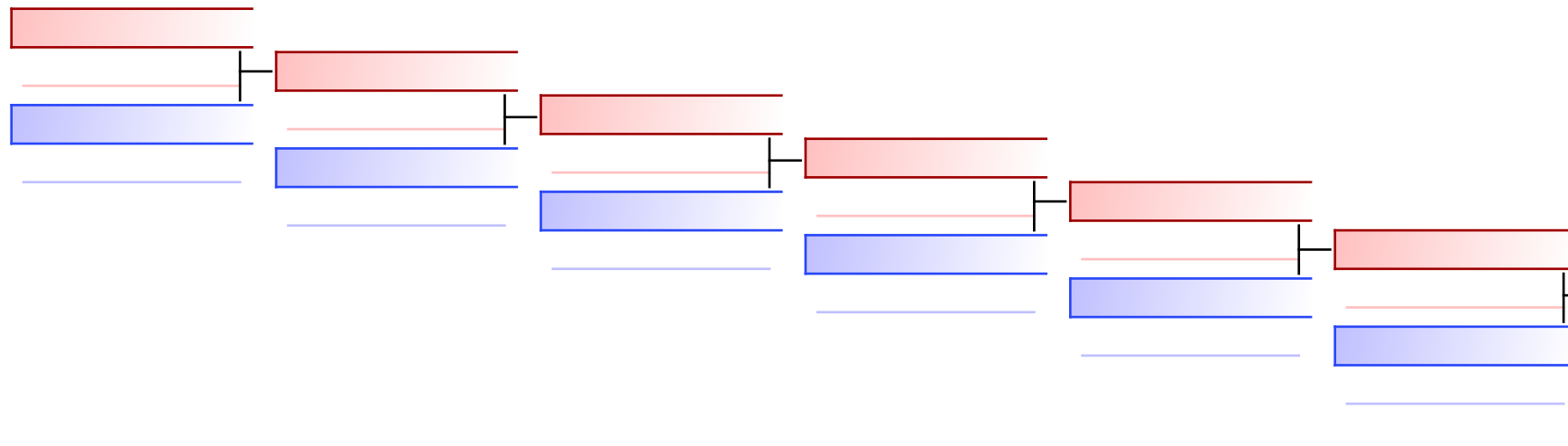

#21  
SOMEYA KAYO (JPN) 2  
ALIKUL LAURA (KAZ) 4

Referees:							
-----------	--	--	--	--	--	--	--

# Female Kumite 68+ Kg - Round Robin (each against each)

Karate1 Premier League - Fukuoka 2023, Fukuoka, JPN

Tatami

Pool  
1/6

1	(*19) ZILLER L. (AUT)		
	#218 PTS	1	(*17) LUCKE A. (GER)
2	(*17) LUCKE A. (GER)		
	PTS	3	
3	(*18) GABALLA Z. (TUR)		
	#219	5	(*18) GABALLA Z. (TUR)
4	(*6) STEPASHKO A. (UKR)		
	PTS	0	
5	(*17) LUCKE A. (GER)		
	#220 PTS	0	(*18) GABALLA Z. (TUR)
6	(*18) GABALLA Z. (TUR)		
	PTS	1	
7	(*19) ZILLER L. (AUT)		
	#221 PTS	1	(*6) STEPASHKO A. (UKR)
8	(*6) STEPASHKO A. (UKR)		
	PTS	6	
9	(*19) ZILLER L. (AUT)		
	#222 PTS	4	(*18) GABALLA Z. (TUR)
10	(*18) GABALLA Z. (TUR)		
	PTS	5	
11	(*17) LUCKE A. (GER)		
	#223	3	(*17) LUCKE A. (GER)
12	(*6) STEPASHKO A. (UKR)		
	PTS	0	



1. SAWAE YUZUKI (JPN)
2. SAITO AYAKA (JPN)
3. BERULTSEVA SOFYA (KAZ)
3. TORRES GARCIA MARIA (ESP)
5. GABALLA ZEYNA (TUR)
5. ABOUISMAIL SOHILA (EGY)
7. KEINANEN TITTA (FIN)
7. UEKUSA AYUMI (JPN)

\*Seeded









Referees:			

# Female Kumite 68+ Kg - Round Robin (each against each)

Karate1 Premier League - Fukuoka 2023, Fukuoka, JPN

Tatami

Pool  
2/6

1	 (*7) SULLIVAN H. (AUS)	0	 (*13) SAWAE Y. (JPN)
	#266 PTS		
2	 (*13) SAWAE Y. (JPN)	6	
3	 (*7) SULLIVAN H. (AUS)	1	 (*3) TORRES GARCIA M. (ESP)
	#270 PTS		
4	 (*3) TORRES GARCIA M. (ESP)	5	
	PTS		
5	 (*13) SAWAE Y. (JPN)	2	 (*13) SAWAE Y. (JPN)
	#268		
6	 (*3) TORRES GARCIA M. (ESP)	0	



1. SAWAE YUZUKI (JPN)
2. SAITO AYAKA (JPN)
3. BERULTSEVA SOFYA (KAZ)
3. TORRES GARCIA MARIA (ESP)
5. GABALLA ZEYNA (TUR)
5. ABOUISMAIL SOHILA (EGY)
7. KEINANEN TITTA (FIN)
7. UEKUSA AYUMI (JPN)

\*Seeded









Referees:			

# Female Kumite 68+ Kg - Round Robin (each against each)

Karate1 Premier League - Fukuoka 2023, Fukuoka, JPN

Tatami

Pool  
3/6

1	 (*11) KAUFMANN F. (SUI)	
	#267	5    (*11) KAUFMANN F. (SUI)
2	 (*8) HO K. (HKG)	
		1
3	 (*11) KAUFMANN F. (SUI)	
	#271 PTS	3    (*2) BERULTSEVA S. (KAZ)
4	 (*2) BERULTSEVA S. (KAZ)	
		7
5	 (*8) HO K. (HKG)	
	#269 PTS	0    (*2) BERULTSEVA S. (KAZ)
6	 (*2) BERULTSEVA S. (KAZ)	
		4



1. SAWAE YUZUKI (JPN)
2. SAITO AYAKA (JPN)
3. BERULTSEVA SOFYA (KAZ)
3. TORRES GARCIA MARIA (ESP)
5. GABALLA ZEYNA (TUR)
5. ABOUISMAIL SOHILA (EGY)
7. KEINANEN TITTA (FIN)
7. UEKUSA AYUMI (JPN)

\*Seeded

Referees:			



# Female Kumite 68+ Kg - Round Robin (each against each)

Karate1 Premier League - Fukuoka 2023, Fukuoka, JPN

Tatami

Pool  
4/6

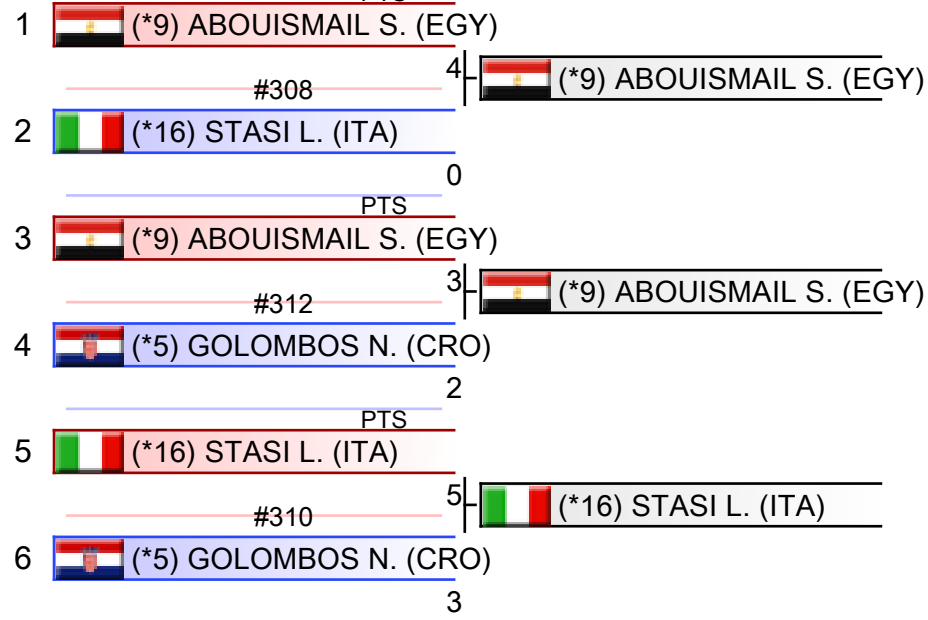

1. SAWAE YUZUKI (JPN)
2. SAITO AYAKA (JPN)
3. BERULTSEVA SOFYA (KAZ)
3. TORRES GARCIA MARIA (ESP)
5. GABALLA ZEYNA (TUR)
5. ABOUISMAIL SOHILA (EGY)
7. KEINANEN TITTA (FIN)
7. UEKUSA AYUMI (JPN)

\*Seeded









Referees:			

# Female Kumite 68+ Kg - Round Robin (each against each)

Karate1 Premier League - Fukuoka 2023, Fukuoka, JPN

Tatami

Pool  
5/6

1	 (*14) RAKAWUNI BANUREA D. (INA)	
	#309	5    (*14) RAKAWUNI BANUREA D. (INA)
2	 (*15) KADOIC M. (SUI)	1
3	 (*14) RAKAWUNI BANUREA D. (INA)	
	#313 PTS	0    (*4) SAITO A. (JPN)
4	 (*4) SAITO A. (JPN)	5
5	 (*15) KADOIC M. (SUI)	
	#311 PTS	0    (*4) SAITO A. (JPN)
6	 (*4) SAITO A. (JPN)	7



1. SAWAE YUZUKI (JPN)
2. SAITO AYAKA (JPN)
3. BERULTSEVA SOFYA (KAZ)
3. TORRES GARCIA MARIA (ESP)
5. GABALLA ZEYNA (TUR)
5. ABOUISMAIL SOHILA (EGY)
7. KEINANEN TITTA (FIN)
7. UEKUSA AYUMI (JPN)

\*Seeded









Referees:			

# Female Kumite 68+ Kg - Round Robin (each against each)

Karate1 Premier League - Fukuoka 2023, Fukuoka, JPN

Tatami

Pool  
6/6

1	 (*10) KEINANEN T. (FIN)	6	 (*10) KEINANEN T. (FIN)
	#353		
2	 (*12) MULOLO O. (BEL)	0	
3	 (*10) KEINANEN T. (FIN)	0	 (*1) UEKUSA A. (JPN)
	#355 PTS		
4	 (*1) UEKUSA A. (JPN)	1	
5	 (*12) MULOLO O. (BEL)	0	 (*1) UEKUSA A. (JPN)
	#354 PTS		
6	 (*1) UEKUSA A. (JPN)	2	



1. SAWAE YUZUKI (JPN)
2. SAITO AYAKA (JPN)
3. BERULTSEVA SOFYA (KAZ)
3. TORRES GARCIA MARIA (ESP)
5. GABALLA ZEYNA (TUR)
5. ABOUISMAIL SOHILA (EGY)
7. KEINANEN TITTA (FIN)
7. UEKUSA AYUMI (JPN)

\*Seeded

Referees:			

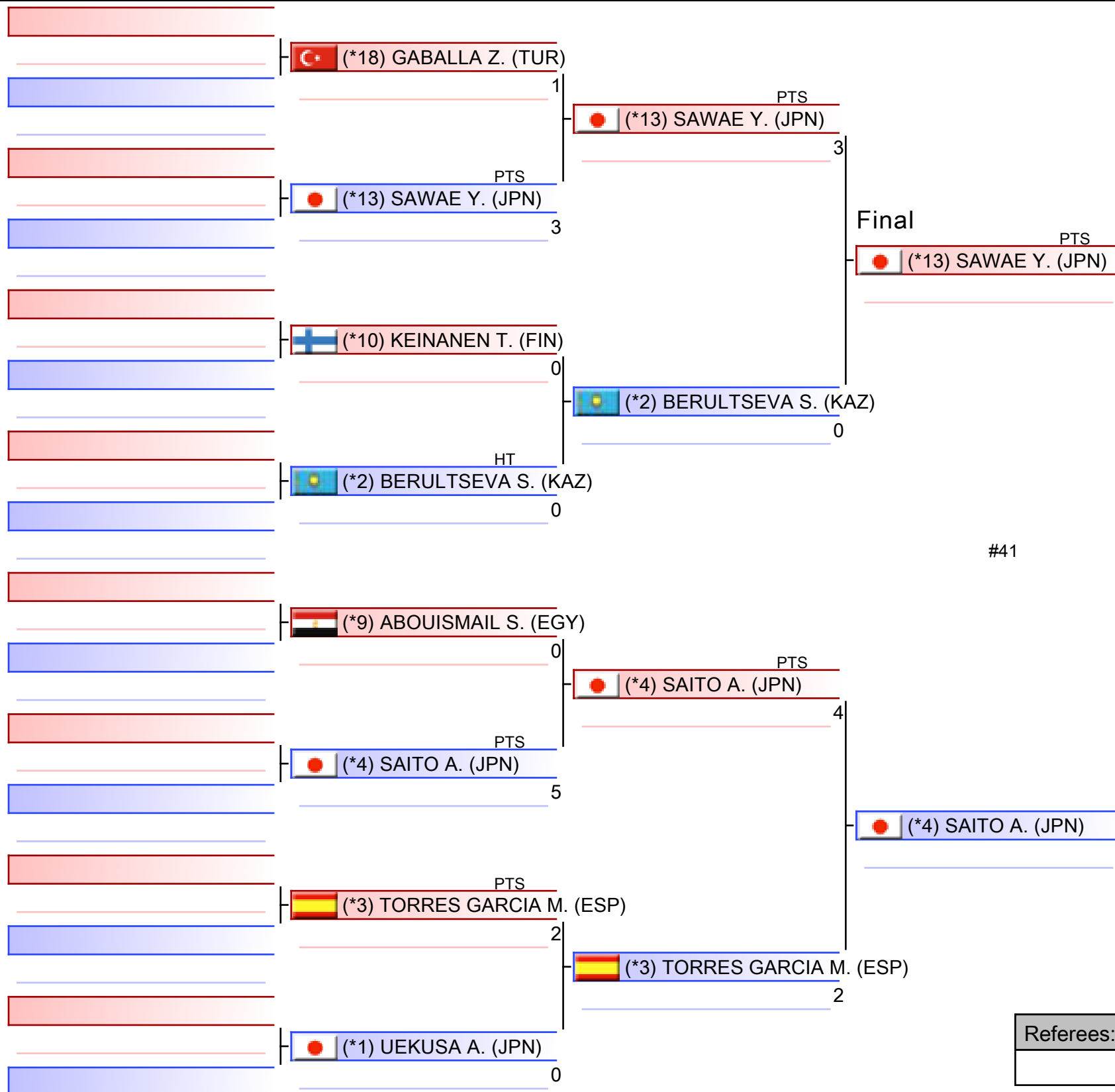

1. SAWAE YUZUKI (JPN)
2. SAITO AYAKA (JPN)
3. BERULTSEVA SOFYA (KAZ)
3. TORRES GARCIA MARIA (ESP)
5. GABALLA ZEYNA (TUR)
5. ABOUISMAIL SOHILA (EGY)
7. KEINANEN TITTA (FIN)
7. UEKUSA AYUMI (JPN)

\*Seeded

Referees:			

**Female Kumite 68+ Kg**  
 Karate1 Premier League - Fukuoka 2023

Tatami Pool  
 1,2,3,4,5,6

(c)sportdata GmbH & Co KG 2000-2023 (2023-06-11 18:09) v 10.0.1 build 1 (2023-05-19 20:00 CET) License: Online\_Event\_ID-705\_Karate1PremierLeagueFukuoka2023 (expire 2023-06-25)

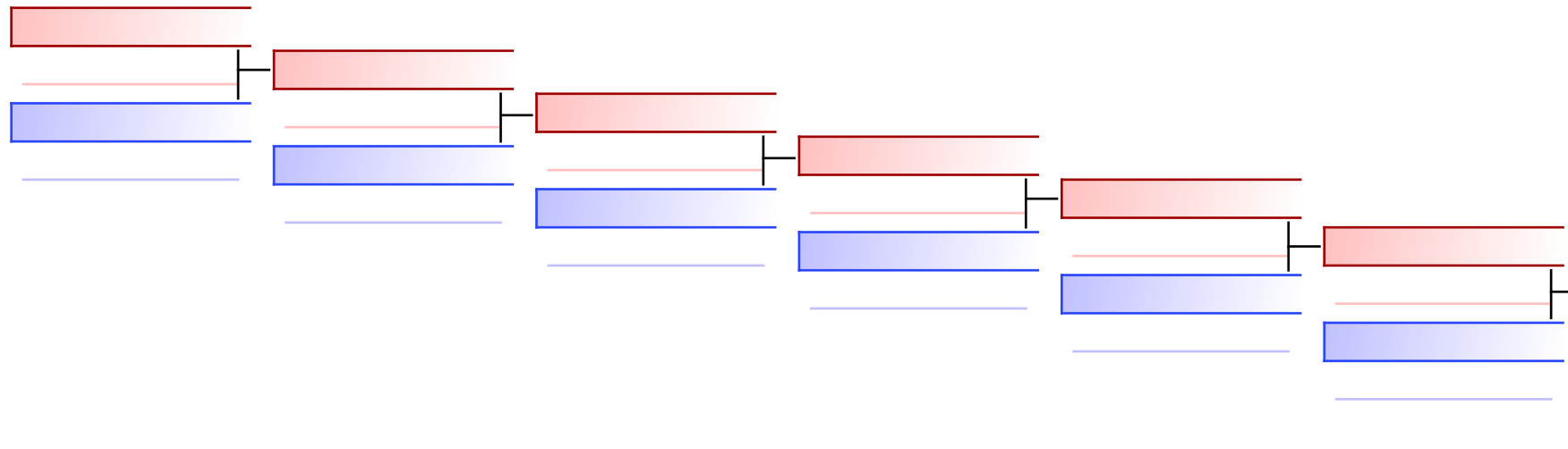

#25

	gaballa zeyna (TUR)	
	PTS	2
	BERULTSEVA SOFYA (KAZ)	5

REPECHAGE: (1,2,3,4,5,6)

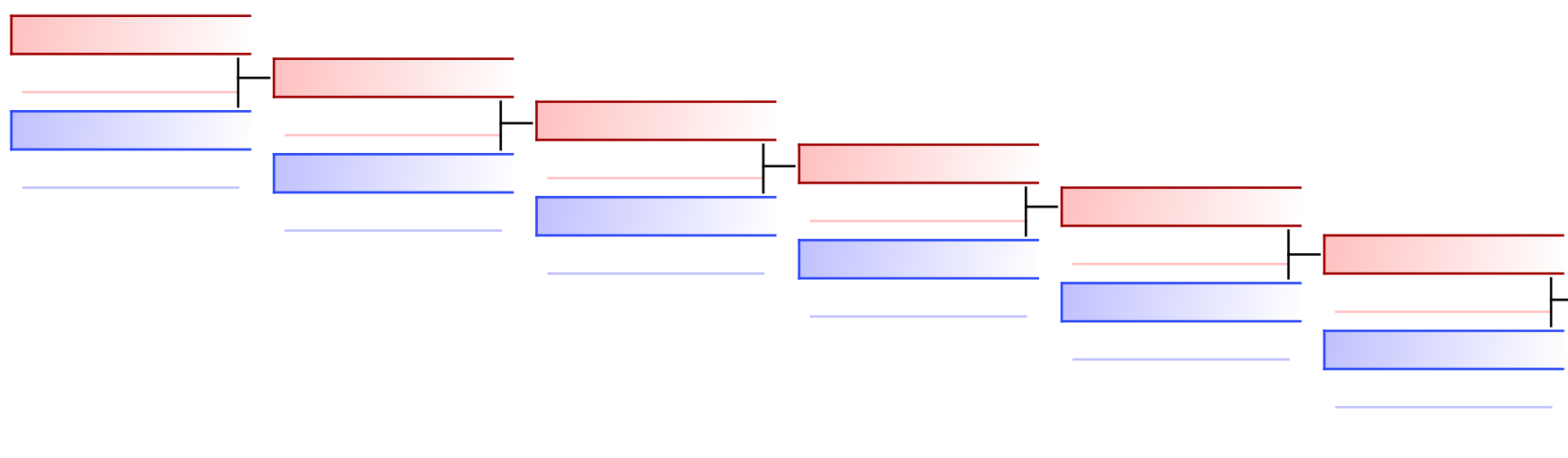

#26

	ABOUISMAIL SOHILA (EGY)	
	PTS	1
	TORRES GARCIA MARIA (ESP)	4



















Referees:							
-----------	--	--	--	--	--	--	--

# Male Kata - Round Robin (each against each)

Karate1 Premier League - Fukuoka 2023, Fukuoka, JPN

Tatami

Pool  
1/8

1	 (*30) PINHEIRO J. (BRA)	064 Ohan Dai #182	3730	 (*21) BANERJEE A. (IND)
2	 (*21) BANERJEE A. (IND)	068 Papuren	3770	
3	 (*9) FUNADA A. (JPN)	009 Chibana No Kushanku #183	4080	 (*9) FUNADA A. (JPN)
4	 (*6) UJIHARA Y. (SUI)	068 Papuren	3840	
5	 (*21) BANERJEE A. (IND)	002 Anan Dai #186	3650	 (*9) FUNADA A. (JPN)
6	 (*9) FUNADA A. (JPN)	098 Unshu	4090	
7	 (*30) PINHEIRO J. (BRA)	002 Anan Dai #187	3620	 (*6) UJIHARA Y. (SUI)
8	 (*6) UJIHARA Y. (SUI)	092 Suparinpei	3960	
9	 (*30) PINHEIRO J. (BRA)	047 Kururunfa #190	3740	 (*9) FUNADA A. (JPN)
10	 (*9) FUNADA A. (JPN)	092 Suparinpei	4130	
11	 (*21) BANERJEE A. (IND)	064 Ohan Dai #191	3700	 (*6) UJIHARA Y. (SUI)
12	 (*6) UJIHARA Y. (SUI)	061 Nipaipo	3910	



1. MOTO KAZUMASA (JPN)
2. KIKUCHI RYONOSUKE (JPN)
3. QUINTERO CAPDEVILA DAMIAN HUGO (ESP)
3. NISHIYAMA KAKERU (JPN)
5. TORRES GUTIERREZ ARIEL (USA)
5. TOZAKI GAKUJI (USA)
7. FUNADA AOI (JPN)
7. ABE SAKICHI (JPN)

\*Seeded

Referees:			

# Male Kata - Round Robin (each against each)

Karate1 Premier League - Fukuoka 2023, Fukuoka, JPN

Tatami

Pool  
2/8

1	(*18) MOTO R. (JPN)	091 Sochin #184	4160	(*18) MOTO R. (JPN)
2	(*12) HUSSAIN M. (KUW)	041 Kanku Sho	3720	
3	(*15) IKEDA R. (JPN)	064 Ohan Dai #185	4070	(*3) TORRES GUTIERREZ A. (USA)
4	(*3) TORRES GUTIERREZ A. (USA)	047 Kururunfa	4170	
5	(*12) HUSSAIN M. (KUW)	099 Unsu #188	3820	(*15) IKEDA R. (JPN)
6	(*15) IKEDA R. (JPN)	063 Ohan	4010	
7	(*18) MOTO R. (JPN)	099 Unsu #189	4110	(*3) TORRES GUTIERREZ A. (USA)
8	(*3) TORRES GUTIERREZ A. (USA)	064 Ohan Dai	4210	
9	(*18) MOTO R. (JPN)	021 Gojushiho Sho #192	4100	(*18) MOTO R. (JPN)
10	(*15) IKEDA R. (JPN)	002 Anan Dai	4050	
11	(*12) HUSSAIN M. (KUW)	021 Gojushiho Sho #193	3890	(*3) TORRES GUTIERREZ A. (USA)
12	(*3) TORRES GUTIERREZ A. (USA)	001 Anan	4170	



1. MOTO KAZUMASA (JPN)
2. KIKUCHI RYONOSUKE (JPN)
3. QUINTERO CAPDEVILA DAMIAN HUGO (ESP)
3. NISHIYAMA KAKERU (JPN)
5. TORRES GUTIERREZ ARIEL (USA)
5. TOZAKI GAKUJI (USA)
7. FUNADA AOI (JPN)
7. ABE SAKICHI (JPN)

\*Seeded

Referees:			

# Male Kata - Round Robin (each against each)

Karate1 Premier League - Fukuoka 2023, Fukuoka, JPN

Tatami

Pool  
3/8

1	(*22) ALMOSAWI S. (KUW)	(*17) MARTIN ROMERO R. (ESP)
	099 Unsu #224	3940
2	(*17) MARTIN ROMERO R. (ESP)	(*13) KIKUCHI R. (JPN)
	001 Anan	4010
3	(*13) KIKUCHI R. (JPN)	(*13) KIKUCHI R. (JPN)
	064 Ohan Dai #225	4160
4	(*7) GHALY K. (EGY)	(*13) KIKUCHI R. (JPN)
	021 Gojushiho Sho	4030
5	(*17) MARTIN ROMERO R. (ESP)	(*13) KIKUCHI R. (JPN)
	008 Chatanyara Kushanku #228	4060
6	(*13) KIKUCHI R. (JPN)	(*13) KIKUCHI R. (JPN)
	001 Anan	4140
7	(*22) ALMOSAWI S. (KUW)	(*7) GHALY K. (EGY)
	015 Gankaku #229	3900
8	(*7) GHALY K. (EGY)	(*13) KIKUCHI R. (JPN)
	041 Kanku Sho	4050
9	(*22) ALMOSAWI S. (KUW)	(*13) KIKUCHI R. (JPN)
	041 Kanku Sho #232	3930
10	(*13) KIKUCHI R. (JPN)	(*13) KIKUCHI R. (JPN)
	002 Anan Dai	4200
11	(*17) MARTIN ROMERO R. (ESP)	(*17) MARTIN ROMERO R. (ESP)
	009 Chibana No Kushanku #233	4110
12	(*7) GHALY K. (EGY)	(*13) KIKUCHI R. (JPN)
	099 Unsu	4100



1. MOTO KAZUMASA (JPN)
2. KIKUCHI RYONOSUKE (JPN)
3. QUINTERO CAPDEVILA DAMIAN HUGO (ESP)
3. NISHIYAMA KAKERU (JPN)
5. TORRES GUTIERREZ ARIEL (USA)
5. TOZAKI GAKUJI (USA)
7. FUNADA AOI (JPN)
7. ABE SAKICHI (JPN)

\*Seeded

Referees:			



# Male Kata - Round Robin (each against each)

Karate1 Premier League - Fukuoka 2023, Fukuoka, JPN

Tatami

Pool  
4/8

1	(*29) YUEN S. (AUS) 047 Kururunfa #226	3790	(*28) HRCKA R. (SVK)
2	(*28) HRCKA R. (SVK) 068 Papuren	3860	
3	(*10) AYATO K. (JPN) 021 Gojushiho Sho #227	4000	(*2) QUINTERO CAPDEVILA D. (ESP)
4	(*2) QUINTERO CAPDEVILA D. (ESP) 064 Ohan Dai	4220	
5	(*28) HRCKA R. (SVK) 002 Anan Dai #230	3890	(*10) AYATO K. (JPN)
6	(*10) AYATO K. (JPN) 020 Gojushiho Dai	4080	
7	(*29) YUEN S. (AUS) 001 Anan #231	3800	(*2) QUINTERO CAPDEVILA D. (ESP)
8	(*2) QUINTERO CAPDEVILA D. (ESP) 066 Pachu	4180	
9	(*29) YUEN S. (AUS) 067 Paiku #234	3660	(*10) AYATO K. (JPN)
10	(*10) AYATO K. (JPN) 099 Unsu	4070	
11	(*28) HRCKA R. (SVK) 009 Chibana No Kushanku #235	3940	(*2) QUINTERO CAPDEVILA D. (ESP)
12	(*2) QUINTERO CAPDEVILA D. (ESP) 047 Kururunfa	4210	



1. MOTO KAZUMASA (JPN)
2. KIKUCHI RYONOSUKE (JPN)
3. QUINTERO CAPDEVILA DAMIAN HUGO (ESP)
3. NISHIYAMA KAKERU (JPN)
5. TORRES GUTIERREZ ARIEL (USA)
5. TOZAKI GAKUJI (USA)
7. FUNADA AOI (JPN)
7. ABE SAKICHI (JPN)

\*Seeded















Referees:			

# Male Kata - Round Robin (each against each)

Karate1 Premier League - Fukuoka 2023, Fukuoka, JPN

Tatami

Pool  
5/8

1	 (*26) ALMOSAWI S. (KUW)	099 Unsu #272	3970	 (*26) ALMOSAWI S. (KUW)
2	 (*19) FEDOROV Y. (UKR)	002 Anan Dai	3940	
3	 (*14) NAGY B. (HUN)	001 Anan		
4	 (*5) MOTO K. (JPN)	012 Enpi		
5	 (*19) FEDOROV Y. (UKR)			
6	 (*14) NAGY B. (HUN)			
7	 (*26) ALMOSAWI S. (KUW)	021 Gojushiho Sho #277	3970	 (*5) MOTO K. (JPN)
8	 (*5) MOTO K. (JPN)	091 Sochin	4250	
9	 (*26) ALMOSAWI S. (KUW)			
10	 (*14) NAGY B. (HUN)			
11	 (*19) FEDOROV Y. (UKR)	064 Ohan Dai #281	3970	 (*5) MOTO K. (JPN)
12	 (*5) MOTO K. (JPN)	020 Gojushiho Dai	4240	



1. MOTO KAZUMASA (JPN)
2. KIKUCHI RYONOSUKE (JPN)
3. QUINTERO CAPDEVILA DAMIAN HUGO (ESP)
3. NISHIYAMA KAKERU (JPN)
5. TORRES GUTIERREZ ARIEL (USA)
5. TOZAKI GAKUJI (USA)
7. FUNADA AOI (JPN)
7. ABE SAKICHI (JPN)

\*Seeded

Referees:			

# Male Kata - Round Robin (each against each)

Karate1 Premier League - Fukuoka 2023, Fukuoka, JPN

Tatami

Pool  
6/8

1	(*27) OTSUKI E. (JPN)	008 Chatanyara Kushanku4060 #274	(*27) OTSUKI E. (JPN)
2	(*25) CHERNIAIEV O. (UKR)	015 Gankaku 3710	
3	(*20) SMORGUNER I. (GER)	002 Anan Dai 3990 #275	(*4) TOZAKI G. (USA)
4	(*4) TOZAKI G. (USA)	064 Ohan Dai 4220	
5	(*25) CHERNIAIEV O. (UKR)	041 Kanku Sho 3700 #278	(*20) SMORGUNER I. (GER)
6	(*20) SMORGUNER I. (GER)	008 Chatanyara Kushanku3980	
7	(*27) OTSUKI E. (JPN)	068 Papuren 4110 #279	(*4) TOZAKI G. (USA)
8	(*4) TOZAKI G. (USA)	002 Anan Dai 4300	
9	(*27) OTSUKI E. (JPN)	092 Suparinpei 4120 #282	(*27) OTSUKI E. (JPN)
10	(*20) SMORGUNER I. (GER)	064 Ohan Dai 3980	
11	(*25) CHERNIAIEV O. (UKR)	099 Unsu 3840 #283	(*4) TOZAKI G. (USA)
12	(*4) TOZAKI G. (USA)	001 Anan 4250	



1. MOTO KAZUMASA (JPN)
2. KIKUCHI RYONOSUKE (JPN)
3. QUINTERO CAPDEVILA DAMIAN HUGO (ESP)
3. NISHIYAMA KAKERU (JPN)
5. TORRES GUTIERREZ ARIEL (USA)
5. TOZAKI GAKUJI (USA)
7. FUNADA AOI (JPN)
7. ABE SAKICHI (JPN)

\*Seeded

Referees:			

# Male Kata - Round Robin (each against each)

Karate1 Premier League - Fukuoka 2023, Fukuoka, JPN

Tatami

Pool  
7/8

1	(*24) KIMURA D. (BRA)	064 Ohan Dai #314	3930	(*23) TOZAKI T. (USA)
2	(*23) TOZAKI T. (USA)	002 Anan Dai	3950	
3	(*31) TAS Y. (FRA)	047 Kururunfa #315	3680	(*8) ABE S. (JPN)
4	(*8) ABE S. (JPN)	001 Anan	4140	
5	(*23) TOZAKI T. (USA)	001 Anan #317	3930	(*23) TOZAKI T. (USA)
6	(*31) TAS Y. (FRA)	063 Ohan	3610	
7	(*24) KIMURA D. (BRA)	068 Papuren #318	3850	(*8) ABE S. (JPN)
8	(*8) ABE S. (JPN)	092 Suparinpei	4180	
9	(*24) KIMURA D. (BRA)	002 Anan Dai #320	3850	(*24) KIMURA D. (BRA)
10	(*31) TAS Y. (FRA)	067 Paiku	3560	
11	(*23) TOZAKI T. (USA)	064 Ohan Dai #321	3820	(*8) ABE S. (JPN)
12	(*8) ABE S. (JPN)	064 Ohan Dai	4210	



1. MOTO KAZUMASA (JPN)
2. KIKUCHI RYONOSUKE (JPN)
3. QUINTERO CAPDEVILA DAMIAN HUGO (ESP)
3. NISHIYAMA KAKERU (JPN)
5. TORRES GUTIERREZ ARIEL (USA)
5. TOZAKI GAKUJI (USA)
7. FUNADA AOI (JPN)
7. ABE SAKICHI (JPN)

\*Seeded







Referees:			

# Male Kata - Round Robin (each against each)

Karate1 Premier League - Fukuoka 2023, Fukuoka, JPN

Tatami

Pool  
8/8

1	 (*11) HUNG H. (HKG)	
	064 Ohan Dai #316	3920
2	 (*16) CHEN C. (TPE)	
	002 Anan Dai	3910
3	 (*11) HUNG H. (HKG)	
	092 Suparinpei #322	3990
4	 (*1) NISHIYAMA K. (JPN)	
	086 Seisan	4230
5	 (*16) CHEN C. (TPE)	
	064 Ohan Dai #319	3850
6	 (*1) NISHIYAMA K. (JPN)	
	090 Shisochin	4200



1. MOTO KAZUMASA (JPN)
2. KIKUCHI RYONOSUKE (JPN)
3. QUINTERO CAPDEVILA DAMIAN HUGO (ESP)
3. NISHIYAMA KAKERU (JPN)
5. TORRES GUTIERREZ ARIEL (USA)
5. TOZAKI GAKUJI (USA)
7. FUNADA AOI (JPN)
7. ABE SAKICHI (JPN)

\*Seeded

Referees:			

# Pool winner-Male Kata

Karate1 Premier League - Fukuoka 2023, Fukuoka, JPN

Tatami

Pool  
1/1

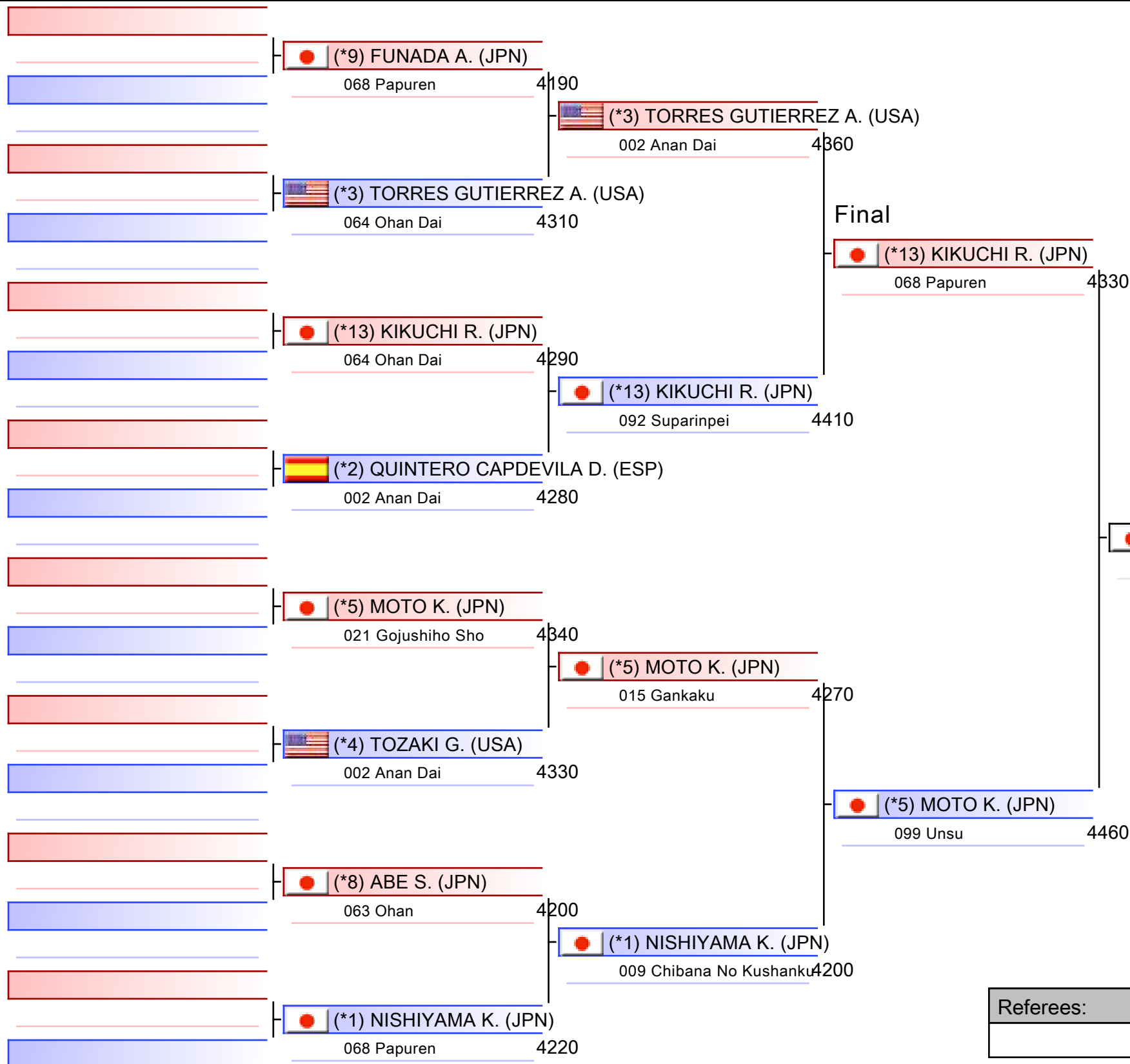

1. MOTO KAZUMASA (JPN)
2. KIKUCHI RYONOSUKE (JPN)
3. QUINTERO CAPDEVILA DAMIAN HUGO (ESP)
3. NISHIYAMA KAKERU (JPN)
5. TORRES GUTIERREZ ARIEL (USA)
5. TOZAKI GAKUJI (USA)
7. FUNADA AOI (JPN)
7. ABE SAKICHI (JPN)

\*Seeded

Referees:			

# Male Kata

Karate1 Premier League - Fukuoka 2023

Tatami

Pool  
1,2,3,4,5,6,7,8

(c)sportdata GmbH & Co KG 2000-2023 (2023-06-11 18:09) v 10.0.1 build 1 (2023-05-19 20:00 CET) License: Online\_Event\_ID-705\_Karate1PremierLeagueFukuoka2023 (expire 2023-06-25)

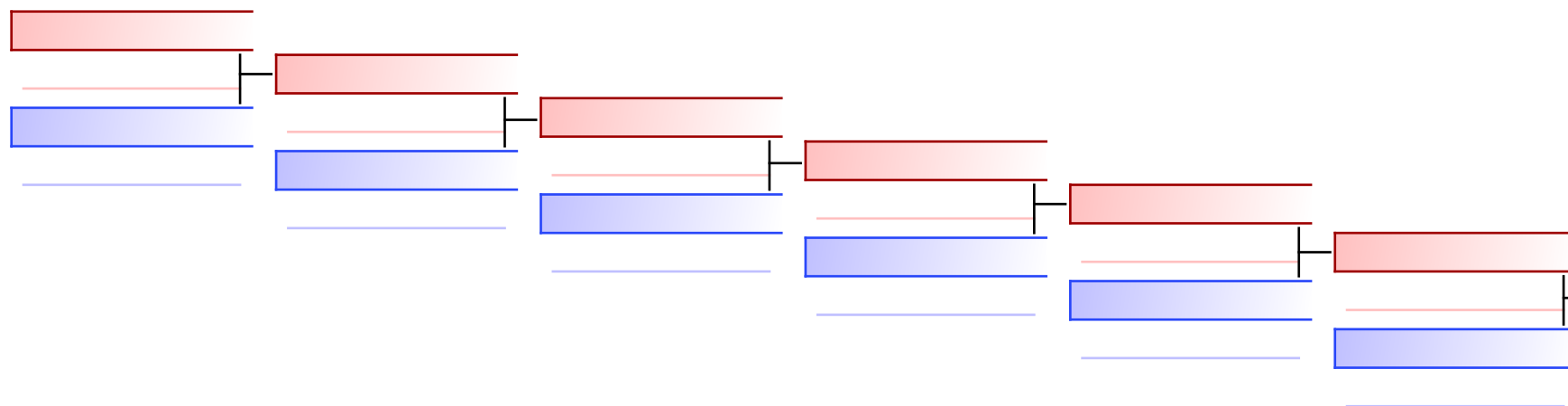

**QUINTERO CAPDEVILA DAMIAN HUGO (ESP)**

064 Ohan Dai 4340

**QUINTERO CAPDEVILA DAMIAN**

**Torres Gutierrez Ariel (USA)**

063 Ohan 4290

## REPECHAGE: (1,2,3,4,5,6,7,8)

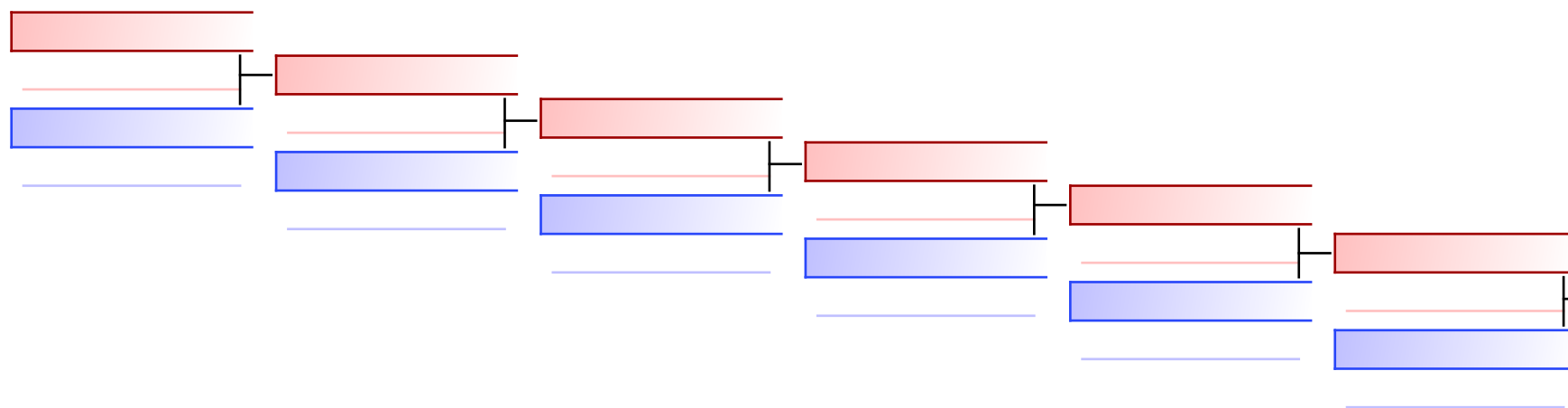

**Tozaki Gakuji (USA)**

008 Chatanyar. 4280

**NISHIYAMA KAKERU (JPN)**

**NISHIYAMA KAKERU (JPN)**

092 Suparinpe. 4510







Referees:							
-----------	--	--	--	--	--	--	--

# Male Kumite -60 Kg - Round Robin (each against each)

Karate1 Premier League - Fukuoka 2023, Fukuoka, JPN

Tatami

Pool  
1/8

1	 (*14) DASOUL M. (BEL)	0
2	 (*18) TAS S. (FRA)	0
3	 (*14) DASOUL M. (BEL)	1
4	 (*6) SAVADOV F. (AZE)	0
5	 (*18) TAS S. (FRA)	0
6	 (*6) SAVADOV F. (AZE)	0



1. HASHIMOTO HIROMU (JPN)
2. TIMRALIYEV DARKHAN (KAZ)
3. HARI SANKAR SUREEYA SANKAR (MAS)
3. HAAS FLORIAN (GER)
5. SHAABAN ABDULLAH (KUW)
5. SHAQRAH OMAR (JOR)
7. DASOUL MICHAEL (BEL)
7. HAMMAD ABDALLAH (JOR)

\*Seeded

Referees:			











# Male Kumite -60 Kg - Round Robin (each against each)

Karate1 Premier League - Fukuoka 2023, Fukuoka, JPN

Tatami

Pool  
2/8

1	 (*19) ABOUKORA A. (EGY)	5	 (*19) ABOUKORA A. (EGY)
2	 (*15) ALBASHER S. (KSA)	2	
3	 (*19) ABOUKORA A. (EGY)	5	 (*3) SHAABAN A. (KUW)
4	 (*3) SHAABAN A. (KUW)	11	
5	 (*15) ALBASHER S. (KSA)	1	 (*3) SHAABAN A. (KUW)
6	 (*3) SHAABAN A. (KUW)	2	



1. HASHIMOTO HIROMU (JPN)
2. TIMRALIYEV DARKHAN (KAZ)
3. HARI SANKAR SUREEYA SANKAR (MAS)
3. HAAS FLORIAN (GER)
5. SHAABAN ABDULLAH (KUW)
5. SHAQRAH OMAR (JOR)
7. DASOUL MICHAEL (BEL)
7. HAMMAD ABDALLAH (JOR)

\*Seeded

Referees:			

# Male Kumite -60 Kg - Round Robin (each against each)

Karate1 Premier League - Fukuoka 2023, Fukuoka, JPN

Tatami

Pool  
3/8

1	(*25) KONDO S. (JPN)	
	PTS	1    (*20) TIMRALIYEV D. (KAZ)
2	(*20) TIMRALIYEV D. (KAZ)	2
3	(*16) IMRICH D. (SVK)	
	PTS	2    (*7) OEZDEMIR M. (GER)
4	(*7) OEZDEMIR M. (GER)	2
	PTS	
5	(*20) TIMRALIYEV D. (KAZ)	
	PTS	2    (*20) TIMRALIYEV D. (KAZ)
6	(*16) IMRICH D. (SVK)	1
	PTS	
7	(*25) KONDO S. (JPN)	
	PTS	0    (*7) OEZDEMIR M. (GER)
8	(*7) OEZDEMIR M. (GER)	1
	PTS	
9	(*25) KONDO S. (JPN)	
	PTS	0    (*16) IMRICH D. (SVK)
10	(*16) IMRICH D. (SVK)	2
	PTS	
11	(*20) TIMRALIYEV D. (KAZ)	
	PTS	3    (*20) TIMRALIYEV D. (KAZ)
12	(*7) OEZDEMIR M. (GER)	1



1. HASHIMOTO HIROMU (JPN)
2. TIMRALIYEV DARKHAN (KAZ)
3. HARI SANKAR SUREEYA SANKAR (MAS)
3. HAAS FLORIAN (GER)
5. SHAABAN ABDULLAH (KUW)
5. SHAQRAH OMAR (JOR)
7. DASOUL MICHAEL (BEL)
7. HAMMAD ABDALLAH (JOR)

\*Seeded







Referees:			

# Male Kumite -60 Kg - Round Robin (each against each)

Karate1 Premier League - Fukuoka 2023, Fukuoka, JPN

Tatami

Pool  
4/8

1	 (*24) GENTILE S. (ITA)	
		PTS
2	 (*23) HARI SANKAR S. (MAS)	1
		5
3	 (*24) GENTILE S. (ITA)	0
4	 (*2) ALPYSBAY K. (KAZ)	0
		PTS
5	 (*23) HARI SANKAR S. (MAS)	1
		2
6	 (*2) ALPYSBAY K. (KAZ)	9



1. HASHIMOTO HIROMU (JPN)
2. TIMRALIYEV DARKHAN (KAZ)
3. HARI SANKAR SUREEYA SANKAR (MAS)
3. HAAS FLORIAN (GER)
5. SHAABAN ABDULLAH (KUW)
5. SHAQRAH OMAR (JOR)
7. DASOUL MICHAEL (BEL)
7. HAMMAD ABDALLAH (JOR)

\*Seeded









Referees:			

# Male Kumite -60 Kg - Round Robin (each against each)

Karate1 Premier League - Fukuoka 2023, Fukuoka, JPN

Tatami

Pool  
5/8

1	 (*13) SHYMYRBEKOV D. (KAZ)	5	 (*13) SHYMYRBEKOV D. (KAZ)
2	 (*26) PRADO ROMAN J. (ESP)	0	
3	 (*13) SHYMYRBEKOV D. (KAZ)	0	 (*5) HAMMAD A. (JOR)
4	 (*5) HAMMAD A. (JOR)	3	
5	 (*26) PRADO ROMAN J. (ESP)	0	 (*5) HAMMAD A. (JOR)
6	 (*5) HAMMAD A. (JOR)	4	



1. HASHIMOTO HIROMU (JPN)
2. TIMRALIYEV DARKHAN (KAZ)
3. HARI SANKAR SUREEYA SANKAR (MAS)
3. HAAS FLORIAN (GER)
5. SHAABAN ABDULLAH (KUW)
5. SHAQRAH OMAR (JOR)
7. DASOUL MICHAEL (BEL)
7. HAMMAD ABDALLAH (JOR)

\*Seeded









Referees:			

# Male Kumite -60 Kg - Round Robin (each against each)

Karate1 Premier League - Fukuoka 2023, Fukuoka, JPN

Tatami

Pool  
6/8

1	 (*22) ZENELAJ L. (BEL)	1	 (*22) ZENELAJ L. (BEL)
2	 (*21) GOGOLOSI B. (ROU)	0	
3	 (*22) ZENELAJ L. (BEL)	0	 (*4) HAAS F. (GER)
4	 (*4) HAAS F. (GER)	2	
5	 (*21) GOGOLOSI B. (ROU)	0	 (*4) HAAS F. (GER)
6	 (*4) HAAS F. (GER)	1	



1. HASHIMOTO HIROMU (JPN)
2. TIMRALIYEV DARKHAN (KAZ)
3. HARI SANKAR SUREEYA SANKAR (MAS)
3. HAAS FLORIAN (GER)
5. SHAABAN ABDULLAH (KUW)
5. SHAQRAH OMAR (JOR)
7. DASOUL MICHAEL (BEL)
7. HAMMAD ABDALLAH (JOR)

\*Seeded



















Referees:			

# Male Kumite -60 Kg - Round Robin (each against each)

Karate1 Premier League - Fukuoka 2023, Fukuoka, JPN

Tatami

Pool  
7/8

1	 (*9) FILIPOV N. (UKR)	0	 (*17) KHALMATOV N. (KAZ)
	PTS		
2	 (*17) KHALMATOV N. (KAZ)	3	
	PTS		
3	 (*12) HASHIMOTO H. (JPN)	9	 (*12) HASHIMOTO H. (JPN)
	PTS		
4	 (*8) CHAU K. (HKG)	2	
	PTS		
5	 (*17) KHALMATOV N. (KAZ)	1	 (*12) HASHIMOTO H. (JPN)
	PTS		
6	 (*12) HASHIMOTO H. (JPN)	9	
	PTS		
7	 (*9) FILIPOV N. (UKR)	1	 (*9) FILIPOV N. (UKR)
	PTS		
8	 (*8) CHAU K. (HKG)	0	
	PTS		
9	 (*9) FILIPOV N. (UKR)	0	 (*12) HASHIMOTO H. (JPN)
	PTS		
10	 (*12) HASHIMOTO H. (JPN)	2	
	PTS		
11	 (*17) KHALMATOV N. (KAZ)	1	 (*8) CHAU K. (HKG)
	PTS		
12	 (*8) CHAU K. (HKG)	2	
	PTS		



1. HASHIMOTO HIROMU (JPN)
2. TIMRALIYEV DARKHAN (KAZ)
3. HARI SANKAR SUREEYA SANKAR (MAS)
3. HAAS FLORIAN (GER)
5. SHAABAN ABDULLAH (KUW)
5. SHAQRAH OMAR (JOR)
7. DASOUL MICHAEL (BEL)
7. HAMMAD ABDALLAH (JOR)

\*Seeded









Referees:			

# Male Kumite -60 Kg - Round Robin (each against each)

Karate1 Premier League - Fukuoka 2023, Fukuoka, JPN

Tatami

Pool  
8/8

1	 (*11) SHAQRAH O. (JOR)	3	 (*11) SHAQRAH O. (JOR)
2	 (*10) HELLAL A. (FRA)	1	
	PTS		
3	 (*11) SHAQRAH O. (JOR)	9	 (*11) SHAQRAH O. (JOR)
4	 (*1) XENOS C. (GRE)	1	
5	 (*10) HELLAL A. (FRA)	0	 (*1) XENOS C. (GRE)
	PTS		
6	 (*1) XENOS C. (GRE)	1	



1. HASHIMOTO HIROMU (JPN)
2. TIMRALIYEV DARKHAN (KAZ)
3. HARI SANKAR SUREEYA SANKAR (MAS)
3. HAAS FLORIAN (GER)
5. SHAABAN ABDULLAH (KUW)
5. SHAQRAH OMAR (JOR)
7. DASOUL MICHAEL (BEL)
7. HAMMAD ABDALLAH (JOR)

\*Seeded

Referees:			

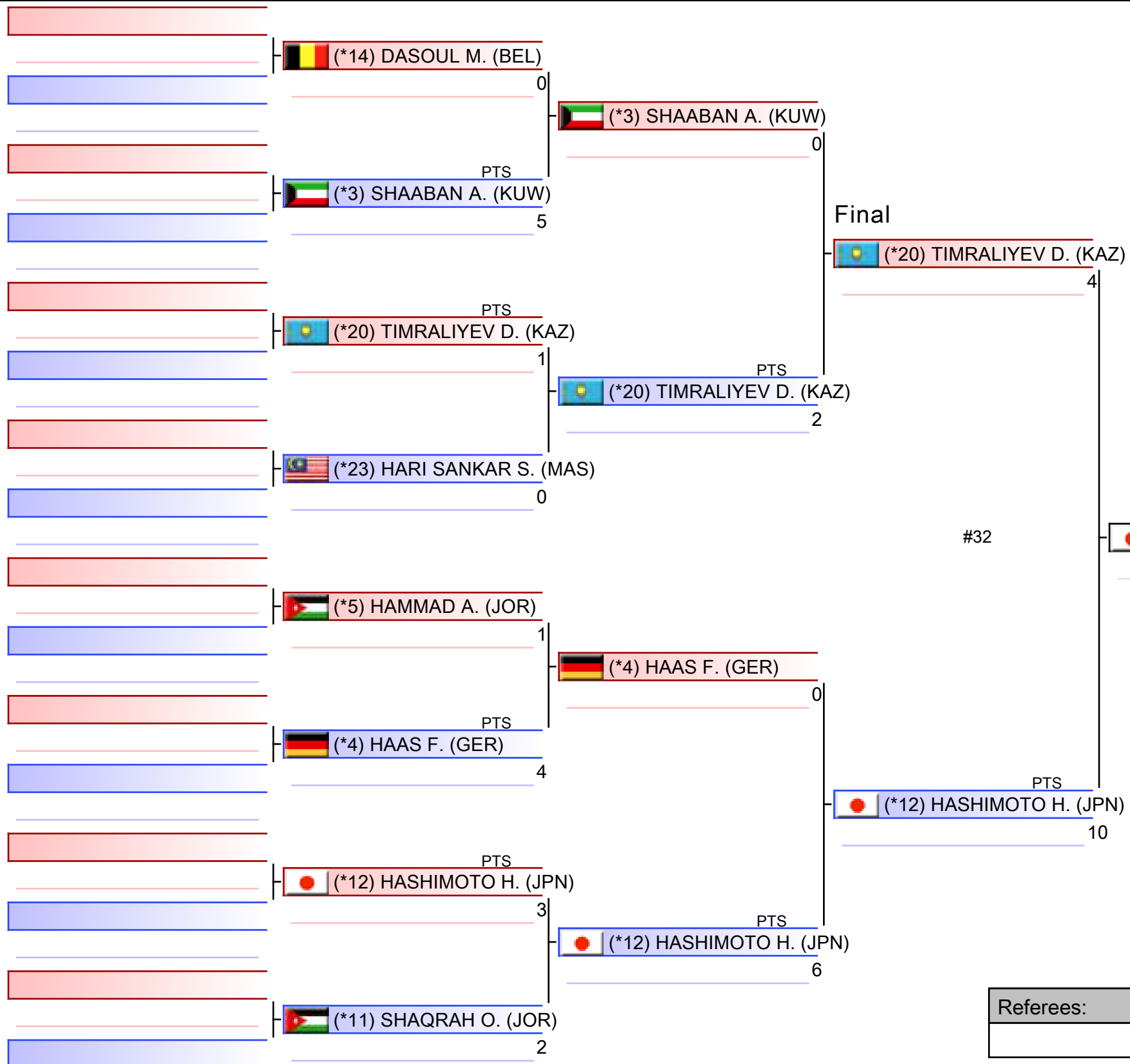

1. HASHIMOTO HIROMU (JPN)
2. TIMRALIYEV DARKHAN (KAZ)
3. HARI SANKAR SUREEYA SANKAR (MAS)
3. HAAS FLORIAN (GER)
5. SHAABAN ABDULLAH (KUW)
5. SHAQRAH OMAR (JOR)
7. DASOUL MICHAEL (BEL)
7. HAMMAD ABDALLAH (JOR)

\*Seeded

Referees:			



# Male Kumite -60 Kg

Karate1 Premier League - Fukuoka 2023

Tatami

Pool

1,2,3,4,5,6,7,8

(c)sportdata GmbH & Co KG 2000-2023 (2023-06-11 18:09) v 10.0.1 build 1 (2023-05-19 20:00 CET) License: Online\_Event\_ID-705\_Karate1PremierLeagueFukuoka2023 (expire 2023-06-25)

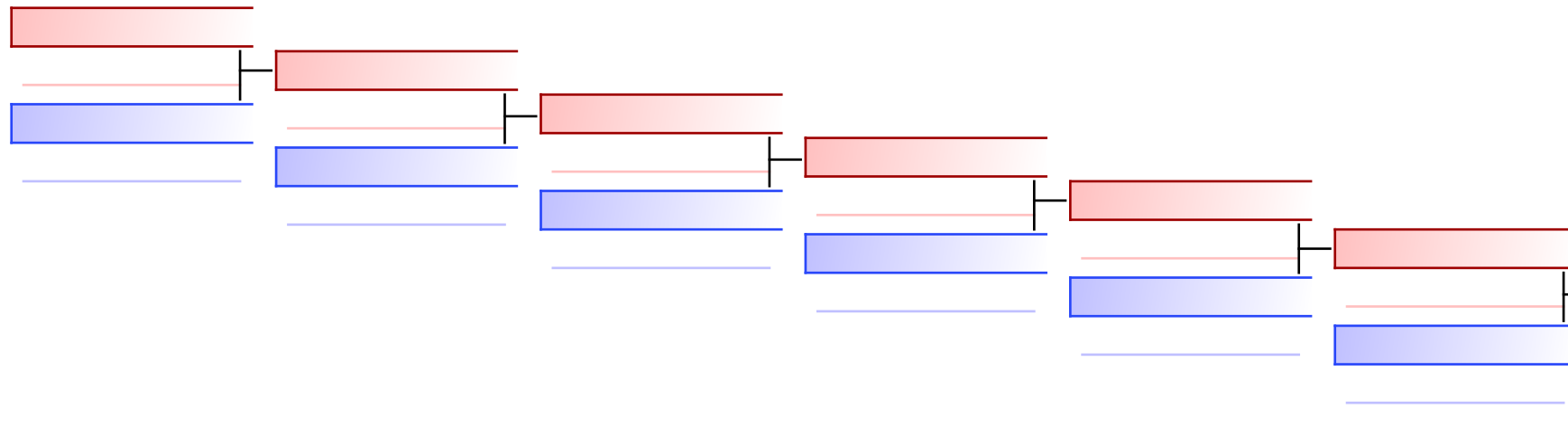

PTS  
 HARI SANKAR SUREEYA SANKAR (MAS) 8  
 SHAABAN ABDULLAH (KUW) 0

## REPECHAGE: (1,2,3,4,5,6,7,8)

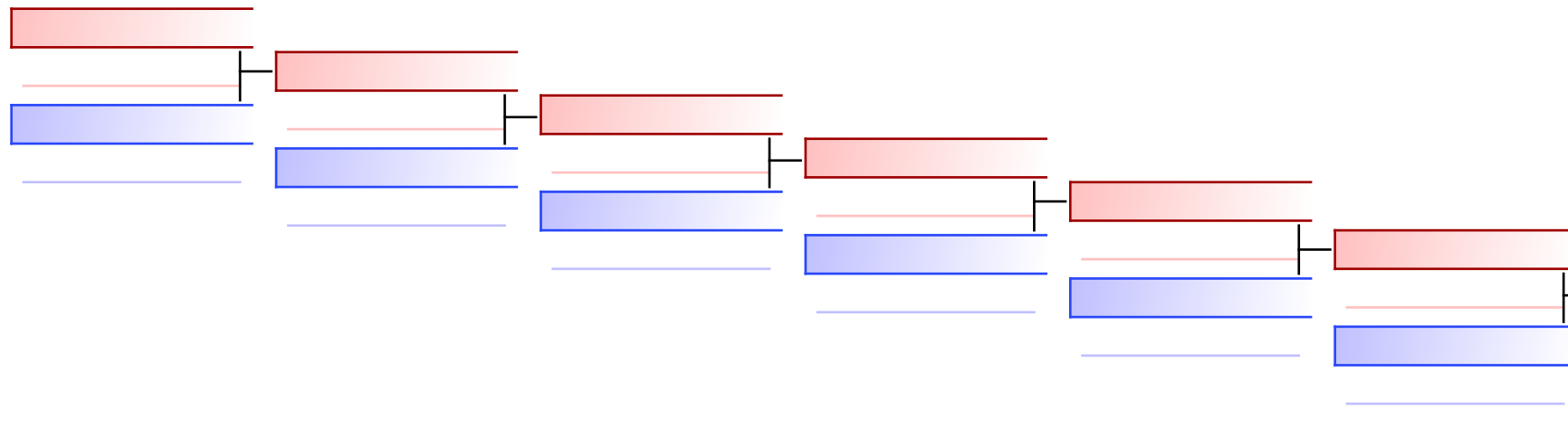

#8  
 SHAQRAH OMAR (JOR) 7  
 HAAS FLORIAN (GER) 0

















Referees:							
-----------	--	--	--	--	--	--	--

# Male Kumite -67 Kg - Round Robin (each against each)

Karate1 Premier League - Fukuoka 2023, Fukuoka, JPN

Tatami

Pool  
1/8

1	 (*9) YANOVSKYI D. (UKR)	2	 (*9) YANOVSKYI D. (UKR)
2	 (*12) MADERA DELGADO A. (VEN)	0	
3	 (*20) WILSON J. (ENG)	0	
4	 (*6) FIGUEIRA V. (BRA)	0	
5	 (*12) MADERA DELGADO A. (VEN)	5	 (*12) MADERA DELGADO A. (VEN)
6	 (*20) WILSON J. (ENG)	1	
7	 (*9) YANOVSKYI D. (UKR)	1	 (*9) YANOVSKYI D. (UKR)
8	 (*6) FIGUEIRA V. (BRA)	0	
9	 (*9) YANOVSKYI D. (UKR)	2	 (*9) YANOVSKYI D. (UKR)
10	 (*20) WILSON J. (ENG)	0	
11	 (*12) MADERA DELGADO A. (VEN)	0	 (*6) FIGUEIRA V. (BRA)
12	 (*6) FIGUEIRA V. (BRA)	7	



1.	ALMASATFA ABDEL RAHMAN (JOR)
2.	GHAITH AFEEF (JOR)
3.	AMIRALI DIDAR (KAZ)
3.	XENOS DIONYSIOS (GRE)
5.	YANOVSKYI DAVYD (UKR)
5.	KOZAKI YUGO (JPN)
7.	NAKANO HIROKI (JPN)
7.	NAKANO SOICHIRO (JPN)

\*Seeded







Referees:			

# Male Kumite -67 Kg - Round Robin (each against each)

Karate1 Premier League - Fukuoka 2023, Fukuoka, JPN

Tatami

Pool  
2/8

1	 (*15) KAMAL D. (KAZ)	0
2	 (*22) RIVOV V. (BUL)	0
3	 (*15) KAMAL D. (KAZ)	0
4	 (*3) ALMASATFA A. (JOR)	8
5	 (*22) RIVOV V. (BUL)	0
6	 (*3) ALMASATFA A. (JOR)	2



1. ALMASATFA ABDEL RAHMAN (JOR)
2. GHAITH AFEEF (JOR)
3. AMIRALI DIDAR (KAZ)
3. XENOS DIONYSIOS (GRE)
5. YANOVSKYI DAVYD (UKR)
5. KOZAKI YUGO (JPN)
7. NAKANO HIROKI (JPN)
7. NAKANO SOICHIRO (JPN)

\*Seeded

Referees:			

# Male Kumite -67 Kg - Round Robin (each against each)

Karate1 Premier League - Fukuoka 2023, Fukuoka, JPN

Tatami

Pool  
3/8

1	(*11) PISINO N. (SUI)	1	
2	(*26) TAS Y. (FRA)	1	
3	(*23) DUARTE R. (POR)	0	(*7) NAKANO H. (JPN)
4	(*7) NAKANO H. (JPN)	2	
5	(*26) TAS Y. (FRA)	2	(*26) TAS Y. (FRA)
6	(*23) DUARTE R. (POR)	1	
7	(*11) PISINO N. (SUI)	0	(*7) NAKANO H. (JPN)
8	(*7) NAKANO H. (JPN)	1	
9	(*11) PISINO N. (SUI)	0	
10	(*23) DUARTE R. (POR)	0	
11	(*26) TAS Y. (FRA)	0	(*7) NAKANO H. (JPN)
12	(*7) NAKANO H. (JPN)	5	



1. ALMASATFA ABDEL RAHMAN (JOR)
2. GHAITH AFEEF (JOR)
3. AMIRALI DIDAR (KAZ)
3. XENOS DIONYSIOS (GRE)
5. YANOVSKYI DAVYD (UKR)
5. KOZAKI YUGO (JPN)
7. NAKANO HIROKI (JPN)
7. NAKANO SOICHIRO (JPN)

\*Seeded







Referees:			

# Male Kumite -67 Kg - Round Robin (each against each)

Karate1 Premier League - Fukuoka 2023, Fukuoka, JPN

Tatami

Pool  
4/8

1	 (*16) OUALAD HAJ AMAR Y. (BEL)	
2	 (*14) BERAK B. (CRO)	
3	 (*16) OUALAD HAJ AMAR Y. (BEL)	
4	 (*2) AMIRALI D. (KAZ)	
5	 (*14) BERAK B. (CRO)	
		0
		PTS
6	 (*2) AMIRALI D. (KAZ)	 (*2) AMIRALI D. (KAZ)
		5



1. ALMASATFA ABDEL RAHMAN (JOR)
2. GHAITH AFEEF (JOR)
3. AMIRALI DIDAR (KAZ)
3. XENOS DIONYSIOS (GRE)
5. YANOVSKYI DAVYD (UKR)
5. KOZAKI YUGO (JPN)
7. NAKANO HIROKI (JPN)
7. NAKANO SOICHIRO (JPN)

\*Seeded

















Referees:			

# Male Kumite -67 Kg - Round Robin (each against each)

Karate1 Premier League - Fukuoka 2023, Fukuoka, JPN

Tatami

Pool  
5/8

1	 (*27) GHAITH A. (JOR)	3	 (*27) GHAITH A. (JOR)
2	 (*21) DI MARCO A. (ITA)	2	
3	 (*19) PAK H. (UKR)	0	
4	 (*5) SHIH C. (TPE)	0	
5	 (*21) DI MARCO A. (ITA)	1	 (*19) PAK H. (UKR)
6	 (*19) PAK H. (UKR)	1	
7	 (*27) GHAITH A. (JOR)	5	 (*27) GHAITH A. (JOR)
8	 (*5) SHIH C. (TPE)	0	
9	 (*27) GHAITH A. (JOR)	8	 (*27) GHAITH A. (JOR)
10	 (*19) PAK H. (UKR)	1	
11	 (*21) DI MARCO A. (ITA)	1	 (*5) SHIH C. (TPE)
12	 (*5) SHIH C. (TPE)	5	



1.	ALMASATFA ABDEL RAHMAN (JOR)
2.	GHAITH AFEEF (JOR)
3.	AMIRALI DIDAR (KAZ)
3.	XENOS DIONYSIOS (GRE)
5.	YANOVSKYI DAVYD (UKR)
5.	KOZAKI YUGO (JPN)
7.	NAKANO HIROKI (JPN)
7.	NAKANO SOICHIRO (JPN)

\*Seeded









Referees:			

# Male Kumite -67 Kg - Round Robin (each against each)

Karate1 Premier League - Fukuoka 2023, Fukuoka, JPN

Tatami

Pool  
6/8

1	 (*13) ALKHATHAMI F. (KSA)	2	 (*18) KOPYTKO D. (UKR)
	PTS		
2	 (*18) KOPYTKO D. (UKR)	2	
3	 (*13) ALKHATHAMI F. (KSA)	0	 (*4) KOZAKI Y. (JPN)
	PTS		
4	 (*4) KOZAKI Y. (JPN)	1	
5	 (*18) KOPYTKO D. (UKR)	0	 (*4) KOZAKI Y. (JPN)
	PTS		
6	 (*4) KOZAKI Y. (JPN)	3	



1. ALMASATFA ABDEL RAHMAN (JOR)
2. GHAITH AFEEF (JOR)
3. AMIRALI DIDAR (KAZ)
3. XENOS DIONYSIOS (GRE)
5. YANOVSKYI DAVYD (UKR)
5. KOZAKI YUGO (JPN)
7. NAKANO HIROKI (JPN)
7. NAKANO SOICHIRO (JPN)

\*Seeded



















Referees:			

# Male Kumite -67 Kg - Round Robin (each against each)

Karate1 Premier League - Fukuoka 2023, Fukuoka, JPN

Tatami

Pool  
7/8

1	 (*25) MUKHAT A. (KAZ)	6	 (*25) MUKHAT A. (KAZ)
2	 (*24) HOMOLA M. (SVK)	4	
3	 (*10) DE VIVO G. (ITA)	1	 (*8) NAKANO S. (JPN)
4	 (*8) NAKANO S. (JPN)	2	
5	 (*24) HOMOLA M. (SVK)	2	 (*10) DE VIVO G. (ITA)
6	 (*10) DE VIVO G. (ITA)	3	
7	 (*25) MUKHAT A. (KAZ)	0	 (*8) NAKANO S. (JPN)
8	 (*8) NAKANO S. (JPN)	2	
9	 (*25) MUKHAT A. (KAZ)	0	 (*10) DE VIVO G. (ITA)
10	 (*10) DE VIVO G. (ITA)	1	
11	 (*24) HOMOLA M. (SVK)	1	 (*8) NAKANO S. (JPN)
12	 (*8) NAKANO S. (JPN)	2	



1.	ALMASATFA ABDEL RAHMAN (JOR)
2.	GHAITH AFEEF (JOR)
3.	AMIRALI DIDAR (KAZ)
3.	XENOS DIONYSIOS (GRE)
5.	YANOVSKYI DAVYD (UKR)
5.	KOZAKI YUGO (JPN)
7.	NAKANO HIROKI (JPN)
7.	NAKANO SOICHIRO (JPN)

\*Seeded

Referees:			









# Male Kumite -67 Kg - Round Robin (each against each)

Karate1 Premier League - Fukuoka 2023, Fukuoka, JPN

Tatami

Pool  
8/8

1	 (*28) IKEDA T. (JPN)	
	PTS	2
2	 (*17) MARESCA L. (ITA)	
		5
3	 (*28) IKEDA T. (JPN)	
	PTS	1
4	 (*1) XENOS D. (GRE)	
		3
5	 (*17) MARESCA L. (ITA)	
	PTS	1
6	 (*1) XENOS D. (GRE)	
		3



1. ALMASATFA ABDEL RAHMAN (JOR)
2. GHAITH AFEEF (JOR)
3. AMIRALI DIDAR (KAZ)
3. XENOS DIONYSIOS (GRE)
5. YANOVSKYI DAVYD (UKR)
5. KOZAKI YUGO (JPN)
7. NAKANO HIROKI (JPN)
7. NAKANO SOICHIRO (JPN)

\*Seeded

Referees:			

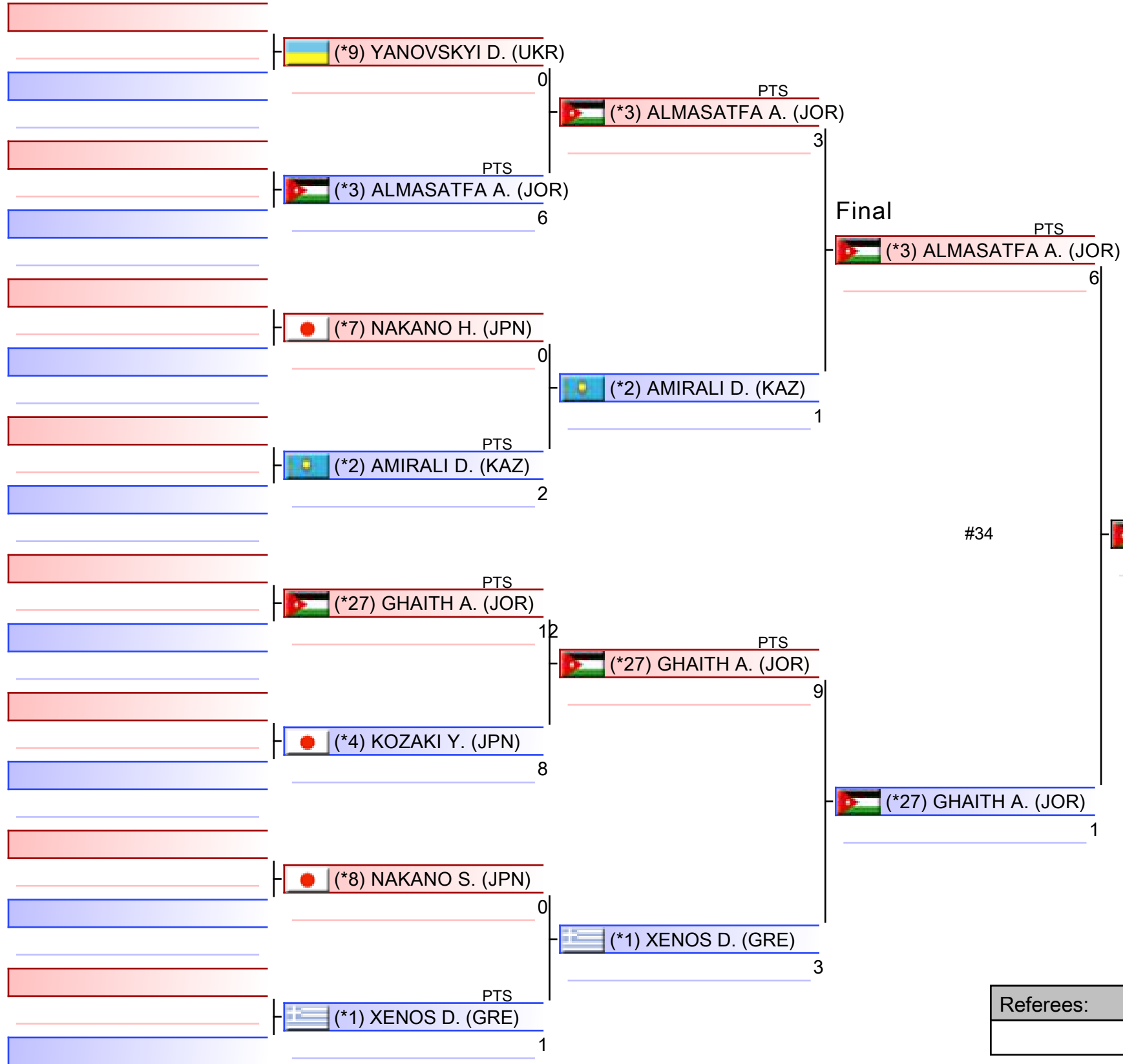

1. ALMASATFA ABDEL RAHMAN (JOR)
2. GHAITH AFEEF (JOR)
3. AMIRALI DIDAR (KAZ)
3. XENOS DIONYSIOS (GRE)
5. YANOVSKYI DAVYD (UKR)
5. KOZAKI YUGO (JPN)
7. NAKANO HIROKI (JPN)
7. NAKANO SOICHIRO (JPN)

\*Seeded

Referees:			

# Male Kumite -67 Kg

Karate1 Premier League - Fukuoka 2023

Tatami

Pool

1,2,3,4,5,6,7,8

(c)sportdata GmbH & Co KG 2000-2023 (2023-06-11 18:09) v 10.0.1 build 1 (2023-05-19 20:00 CET) License: Online\_Event\_ID-705\_Karate1PremierLeagueFukuoka2023 (expire 2023-06-25)

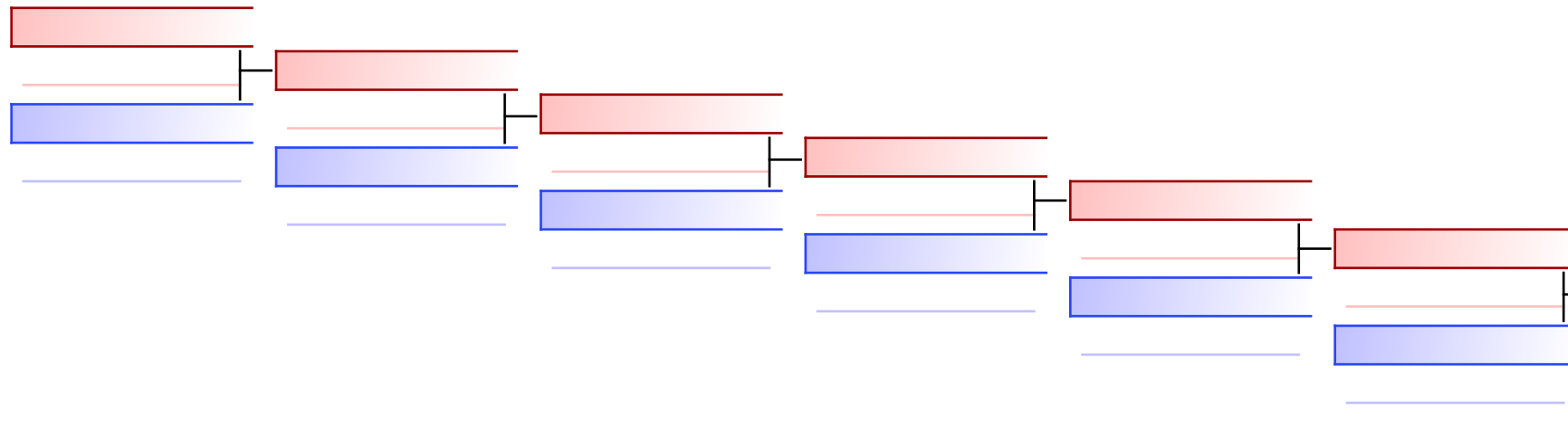

#11

	YANOVSKYI DAVYD (UKR)	PTS	0
	AMIRALI DIDAR (KAZ)		1

## REPECHAGE: (1,2,3,4,5,6,7,8)

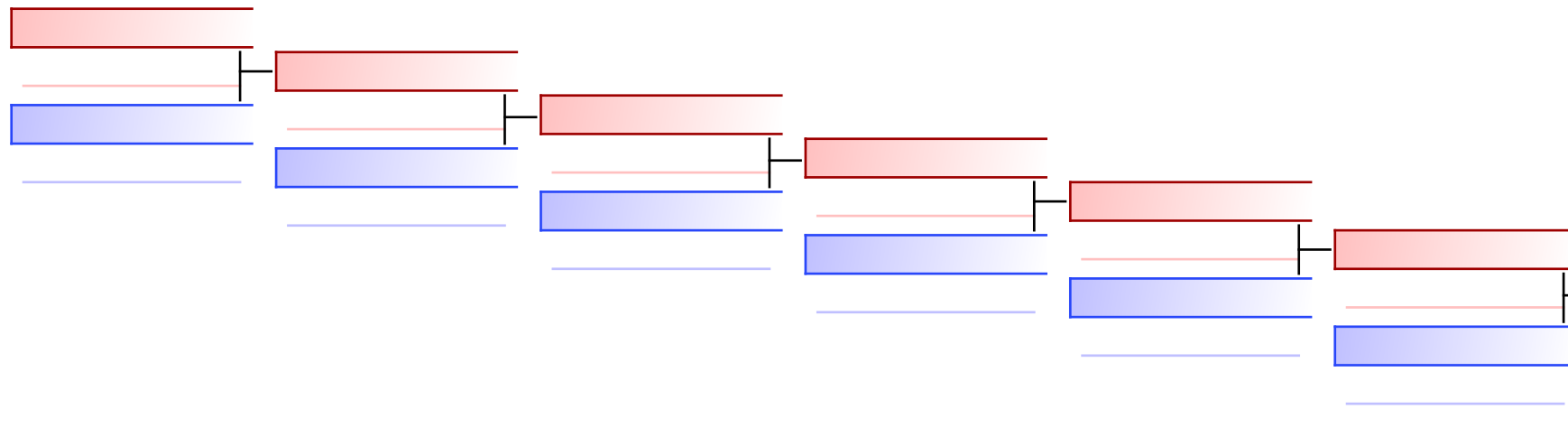

#12

	KOZAKI YUGO (JPN)	PTS	1
	XENOS DIONYSIOS (GRE)		2









Referees:							
-----------	--	--	--	--	--	--	--

# Male Kumite -75 Kg - Round Robin (each against each)

Karate1 Premier League - Fukuoka 2023, Fukuoka, JPN

Tatami

Pool  
1/8

1	 (*14) CHERNIAIEV O. (UKR)	2	 (*11) DURHAM M. (AUS)
	PTS		
2	 (*11) DURHAM M. (AUS)	4	
3	 (*14) CHERNIAIEV O. (UKR)	0	 (*6) ABDELGAWAD A. (EGY)
	PTS		
4	 (*6) ABDELGAWAD A. (EGY)	4	
5	 (*11) DURHAM M. (AUS)	0	 (*6) ABDELGAWAD A. (EGY)
	PTS		
6	 (*6) ABDELGAWAD A. (EGY)	7	



1. PIETROMARCHI LORENZO (ITA)
2. YURUR OMER FARUK (TUR)
3. MAHAUDEN QUENTIN (BEL)
3. DE VIVO DANIELE (ITA)
5. AZHIKANOV NURKANAT (KAZ)
5. ZAPLITNYI ANDRII (UKR)
7. ABDELGAWAD ABDALLA HESHAM (EGY)
7. SAKIYAMA YUSEI (JPN)

\*Seeded









Referees:			

# Male Kumite -75 Kg - Round Robin (each against each)

Karate1 Premier League - Fukuoka 2023, Fukuoka, JPN

Tatami

Pool  
2/8

1	 (*17) POKORNY S. (AUT)	4	 (*17) POKORNY S. (AUT)
2	 (*19) MARAT A. (KAZ)	0	
3	 (*17) POKORNY S. (AUT)	0	 (*3) MAHAUDEN Q. (BEL)
4	 (*3) MAHAUDEN Q. (BEL)	3	
5	 (*19) MARAT A. (KAZ)	0	 (*3) MAHAUDEN Q. (BEL)
6	 (*3) MAHAUDEN Q. (BEL)	1	



1. PIETROMARCHI LORENZO (ITA)
2. YURUR OMER FARUK (TUR)
3. MAHAUDEN QUENTIN (BEL)
3. DE VIVO DANIELE (ITA)
5. AZHIKANOV NURKANAT (KAZ)
5. ZAPLITNYI ANDRII (UKR)
7. ABDELGAWAD ABDALLA HESHAM (EGY)
7. SAKIYAMA YUSEI (JPN)

\*Seeded









Referees:			

# Male Kumite -75 Kg - Round Robin (each against each)

Karate1 Premier League - Fukuoka 2023, Fukuoka, JPN

Tatami

Pool  
3/8

1	 (*16) RODRIGUEZ FUENTES M. (CHI)	3	 (*12) YURUR O. (TUR)
	PTS		
2	 (*12) YURUR O. (TUR)	4	
	PTS		
3	 (*16) RODRIGUEZ FUENTES M. (CHI)	0	 (*7) ALZHRANI S. (KSA)
	PTS		
4	 (*7) ALZHRANI S. (KSA)	1	
	PTS		
5	 (*12) YURUR O. (TUR)	5	 (*12) YURUR O. (TUR)
	PTS		
6	 (*7) ALZHRANI S. (KSA)	3	
	PTS		



1. PIETROMARCHI LORENZO (ITA)
2. YURUR OMER FARUK (TUR)
3. MAHAUDEN QUENTIN (BEL)
3. DE VIVO DANIELE (ITA)
5. AZHIKANOV NURKANAT (KAZ)
5. ZAPLITNYI ANDRII (UKR)
7. ABDELGAWAD ABDALLA HESHAM (EGY)
7. SAKIYAMA YUSEI (JPN)

\*Seeded

Referees:			

# Male Kumite -75 Kg - Round Robin (each against each)

Karate1 Premier League - Fukuoka 2023, Fukuoka, JPN

Tatami

Pool  
4/8

1	(*25) TONG Y. (TPE)	7	(*25) TONG Y. (TPE)
2	(*21) SUZUKI S. (JPN)	1	
3	(*25) TONG Y. (TPE)	7	(*2) AZHIKANOV N. (KAZ)
4	(*2) AZHIKANOV N. (KAZ)	13	
5	(*21) SUZUKI S. (JPN)	10	(*21) SUZUKI S. (JPN)
6	(*2) AZHIKANOV N. (KAZ)	2	



1. PIETROMARCHI LORENZO (ITA)
2. YURUR OMER FARUK (TUR)
3. MAHAUDEN QUENTIN (BEL)
3. DE VIVO DANIELE (ITA)
5. AZHIKANOV NURKANAT (KAZ)
5. ZAPLITNYI ANDRII (UKR)
7. ABDELGAWAD ABDALLA HESHAM (EGY)
7. SAKIYAMA YUSEI (JPN)

\*Seeded









Referees:			

# Male Kumite -75 Kg - Round Robin (each against each)

Karate1 Premier League - Fukuoka 2023, Fukuoka, JPN

Tatami

Pool  
5/8

1	 (*15) ALJENAEI O. (KUW)	0	 (*23) SAKIYAMA Y. (JPN)
	PTS		
2	 (*23) SAKIYAMA Y. (JPN)	1	
3	 (*15) ALJENAEI O. (KUW)	3	 (*5) MASARWEH H. (JOR)
	PTS		
4	 (*5) MASARWEH H. (JOR)	5	
	PTS		
5	 (*23) SAKIYAMA Y. (JPN)	6	 (*23) SAKIYAMA Y. (JPN)
	PTS		
6	 (*5) MASARWEH H. (JOR)	4	
	PTS		



1. PIETROMARCHI LORENZO (ITA)
2. YURUR OMER FARUK (TUR)
3. MAHAUDEN QUENTIN (BEL)
3. DE VIVO DANIELE (ITA)
5. AZHIKANOV NURKANAT (KAZ)
5. ZAPLITNYI ANDRII (UKR)
7. ABDELGAWAD ABDALLA HESHAM (EGY)
7. SAKIYAMA YUSEI (JPN)

\*Seeded

Referees:			









# Male Kumite -75 Kg - Round Robin (each against each)

Karate1 Premier League - Fukuoka 2023, Fukuoka, JPN

Tatami

Pool  
6/8

1	 (*9) EL SHARABY A. (ITA)	0
2	 (*24) PAN P. (TPE)	0
3	 (*9) EL SHARABY A. (ITA)	1
4	 (*4) ZAPLITNYI A. (UKR)	1
5	 (*24) PAN P. (TPE)	0
6	 (*4) ZAPLITNYI A. (UKR)	0



1. PIETROMARCHI LORENZO (ITA)
2. YURUR OMER FARUK (TUR)
3. MAHAUDEN QUENTIN (BEL)
3. DE VIVO DANIELE (ITA)
5. AZHIKANOV NURKANAT (KAZ)
5. ZAPLITNYI ANDRII (UKR)
7. ABDELGAWAD ABDALLA HESHAM (EGY)
7. SAKIYAMA YUSEI (JPN)

\*Seeded

Referees:			

# Male Kumite -75 Kg - Round Robin (each against each)

Karate1 Premier League - Fukuoka 2023, Fukuoka, JPN

Tatami

Pool  
7/8

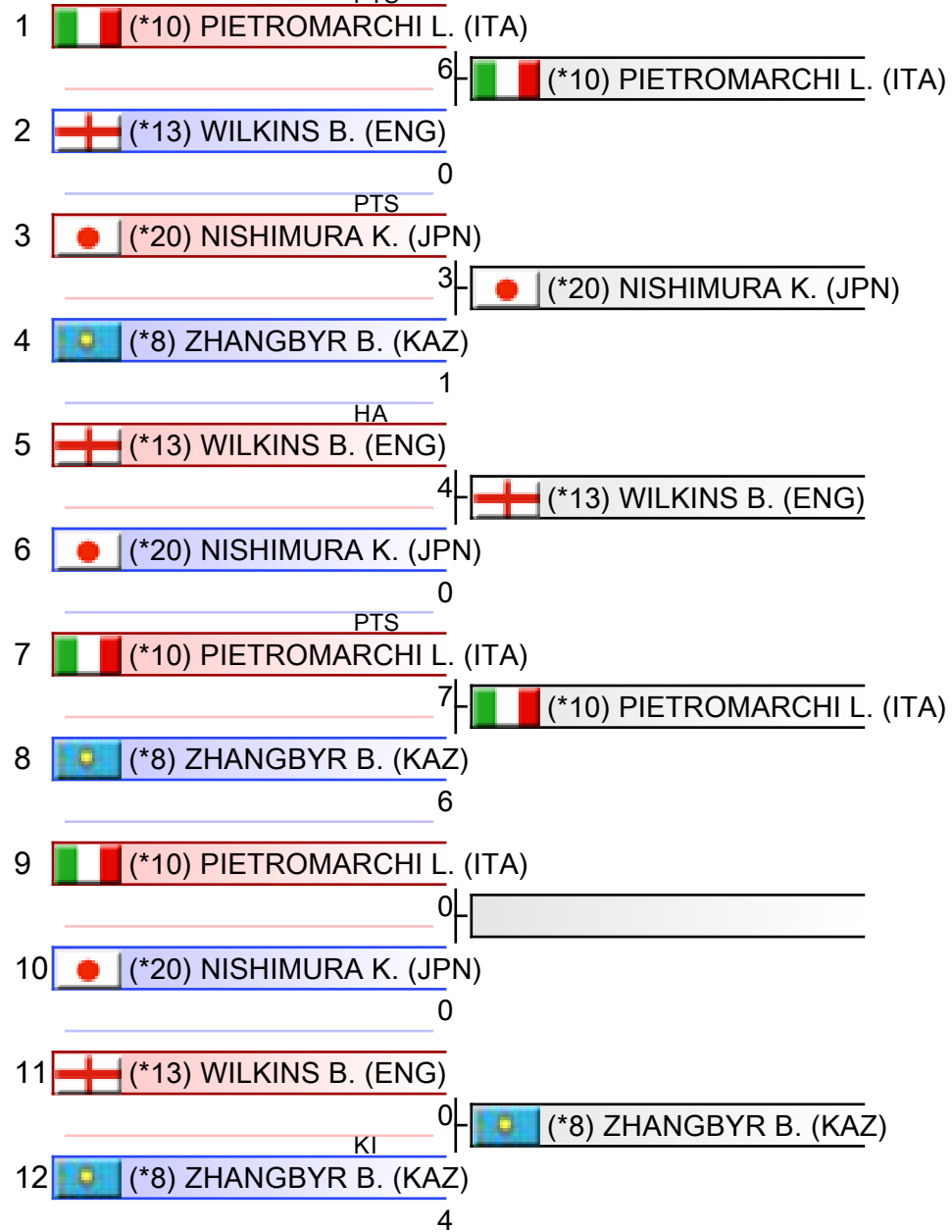

1. PIETROMARCHI LORENZO (ITA)
2. YURUR OMER FARUK (TUR)
3. MAHAUDEN QUENTIN (BEL)
3. DE VIVO DANIELE (ITA)
5. AZHIKANOV NURKANAT (KAZ)
5. ZAPLITNYI ANDRII (UKR)
7. ABDELGAWAD ABDALLA HESHAM (EGY)
7. SAKIYAMA YUSEI (JPN)

\*Seeded









Referees:			

# Male Kumite -75 Kg - Round Robin (each against each)

Karate1 Premier League - Fukuoka 2023, Fukuoka, JPN

Tatami

Pool  
8/8

1	 (*22) GONZALEZ LAVIN J. (CHI)	6	 (*22) GONZALEZ LAVIN J. (CHI)
2	 (*18) JANOVCIK M. (SVK)	4	
3	 (*22) GONZALEZ LAVIN J. (CHI)	5	 (*1) DE VIVO D. (ITA)
4	 (*1) DE VIVO D. (ITA)	7	
5	 (*18) JANOVCIK M. (SVK)	0	 (*1) DE VIVO D. (ITA)
6	 (*1) DE VIVO D. (ITA)	2	



1. PIETROMARCHI LORENZO (ITA)
2. YURUR OMER FARUK (TUR)
3. MAHAUDEN QUENTIN (BEL)
3. DE VIVO DANIELE (ITA)
5. AZHIKANOV NURKANAT (KAZ)
5. ZAPLITNYI ANDRII (UKR)
7. ABDELGAWAD ABDALLA HESHAM (EGY)
7. SAKIYAMA YUSEI (JPN)

\*Seeded

Referees:			

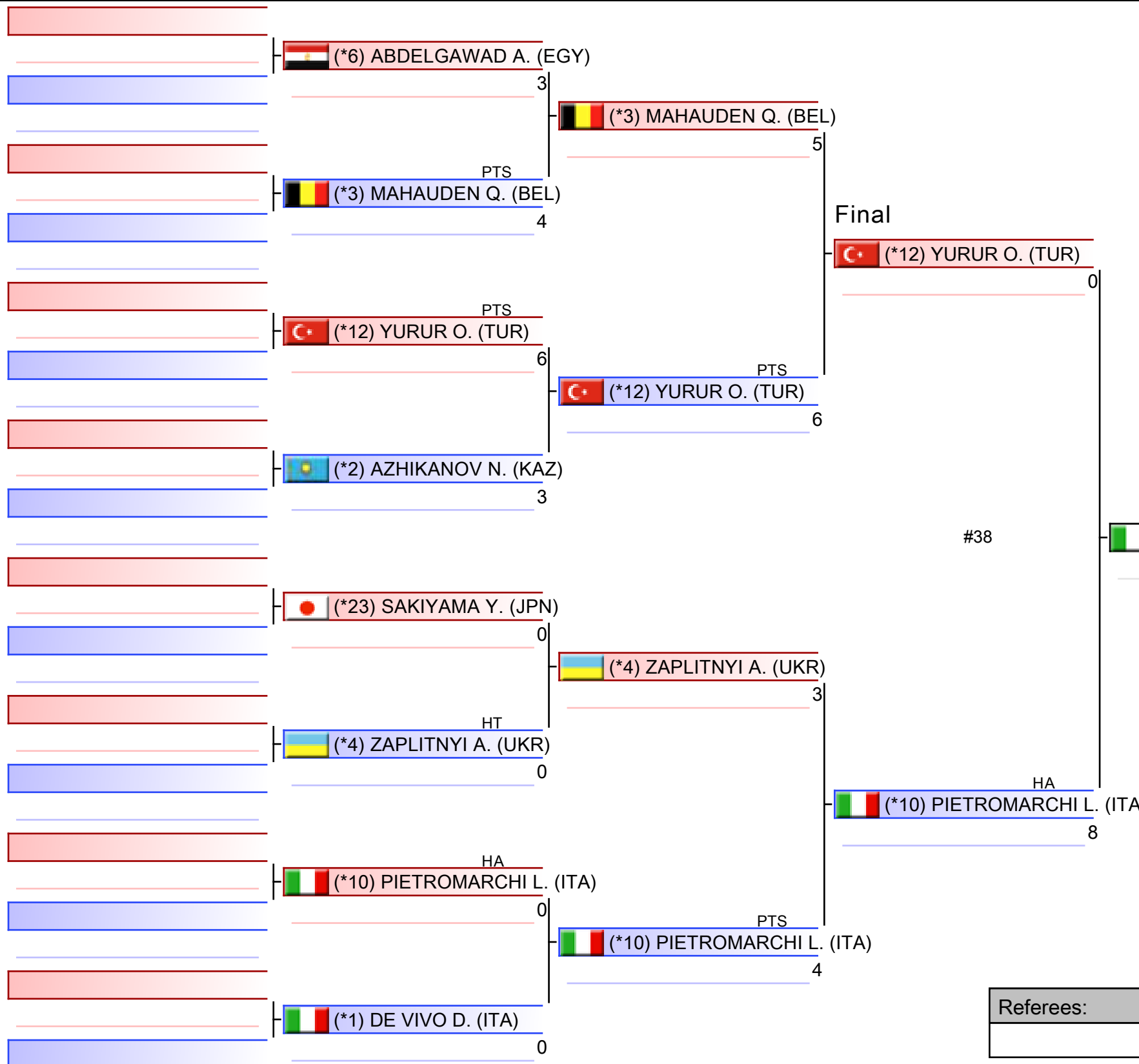

1. PIETROMARCHI LORENZO (ITA)
2. YURUR OMER FARUK (TUR)
3. MAHAUDEN QUENTIN (BEL)
3. DE VIVO DANIELE (ITA)
5. AZHIKANOV NURKANAT (KAZ)
5. ZAPLITNYI ANDRII (UKR)
7. ABDELGAWAD ABDALLA HESHAM (EGY)
7. SAKIYAMA YUSEI (JPN)

\*Seeded

Referees:			

# Male Kumite -75 Kg

Karate1 Premier League - Fukuoka 2023

Tatami

Pool

1,2,3,4,5,6,7,8

(c)sportdata GmbH & Co KG 2000-2023 (2023-06-11 18:09) v 10.0.1 build 1 (2023-05-19 20:00 CET) License: Online\_Event\_ID-705\_Karate1PremierLeagueFukuoka2023 (expire 2023-06-25)

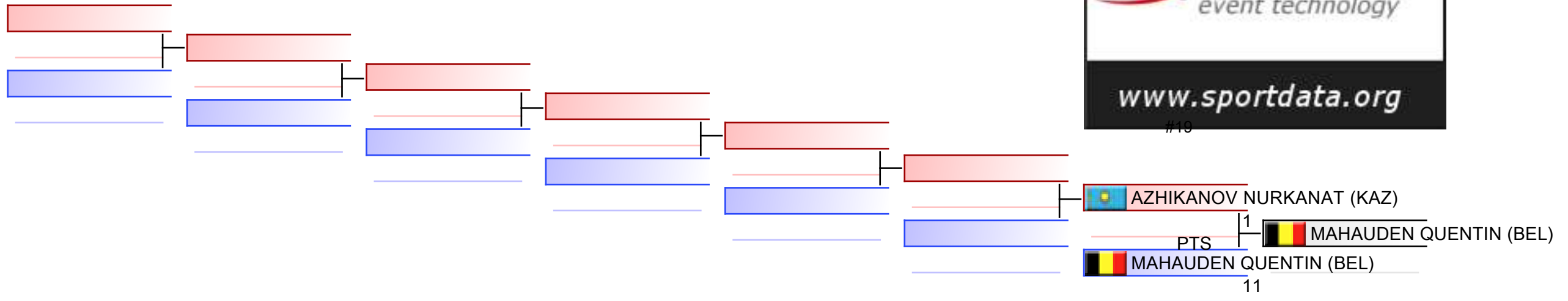

## REPECHAGE: (1,2,3,4,5,6,7,8)

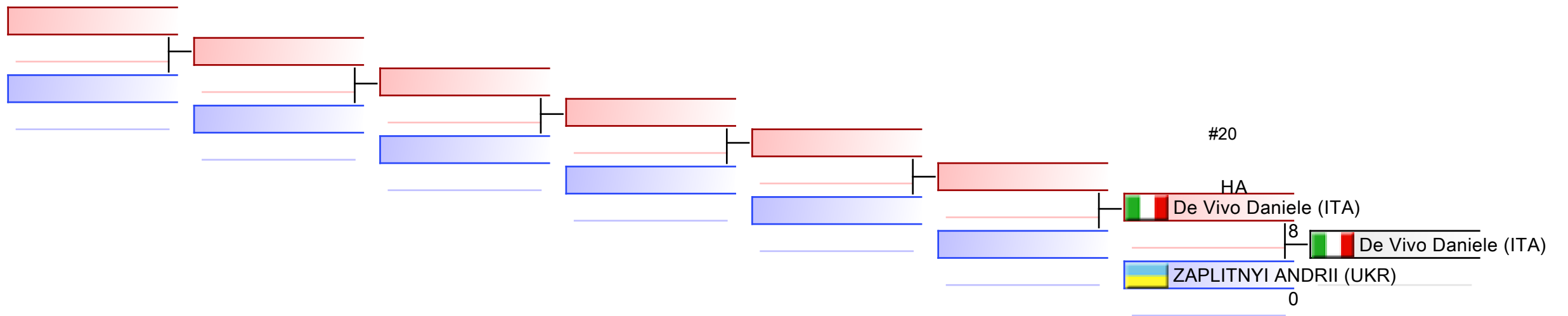

Referees:							
-----------	--	--	--	--	--	--	--

# Male Kumite -84 Kg - Round Robin (each against each)

Karate1 Premier League - Fukuoka 2023, Fukuoka, JPN

Tatami

Pool  
1/8

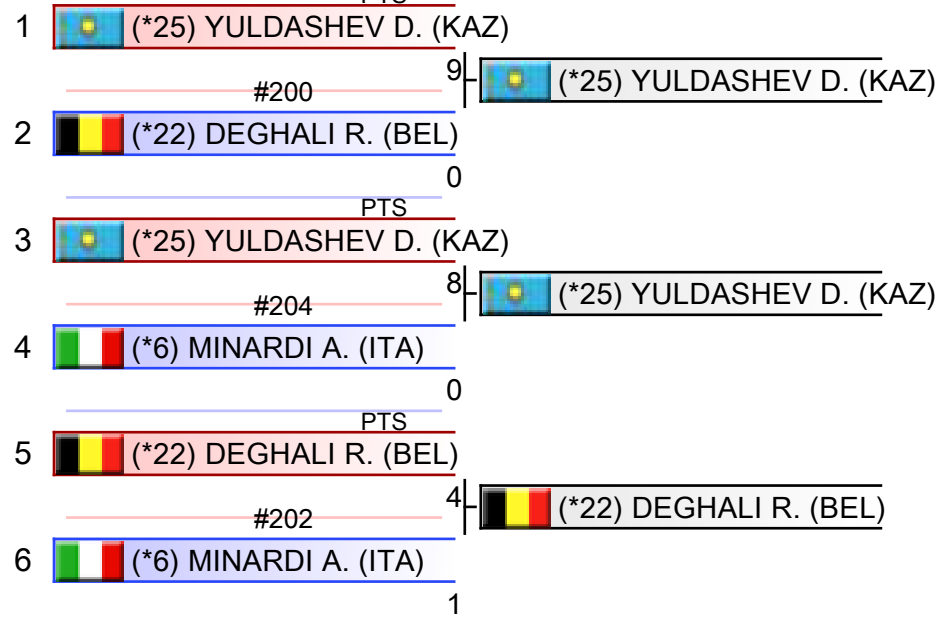

1. ALJAFARI MOHAMMAD (JOR)
2. KVESIC IVAN (CRO)
3. ETO JUNYA (JPN)
3. CHOBOTAR VALERII (UKR)
5. ABDESSELEM RAYBAK (FRA)
5. TIMMERMANS BRIAN (NED)
7. YULDASHEV DANIYAR (KAZ)
7. FIORE MATTEO (ITA)

\*Seeded

Referees:			

# Male Kumite -84 Kg - Round Robin (each against each)

Karate1 Premier League - Fukuoka 2023, Fukuoka, JPN

Tatami

Pool  
2/8

1	(*16) SENPON S. (USA)	1	(*16) SENPON S. (USA)
	#201		
2	(*18) ZAID O. (ALG)	0	
3	(*16) SENPON S. (USA)	0	(*3) ETO J. (JPN)
	#205 PTS		
4	(*3) ETO J. (JPN)	6	
5	(*18) ZAID O. (ALG)	0	(*3) ETO J. (JPN)
	#203 PTS		
6	(*3) ETO J. (JPN)	1	



1. ALJAFARI MOHAMMAD (JOR)
2. KVESIC IVAN (CRO)
3. ETO JUNYA (JPN)
3. CHOBOTAR VALERII (UKR)
5. ABDESSELEM RAYBAK (FRA)
5. TIMMERMANS BRIAN (NED)
7. YULDASHEV DANIYAR (KAZ)
7. FIORE MATTEO (ITA)

\*Seeded

Referees:			

# Male Kumite -84 Kg - Round Robin (each against each)

Karate1 Premier League - Fukuoka 2023, Fukuoka, JPN

Tatami

Pool  
3/8

1	(*19) MOHAMED O. (EGY)	#242	PTS	6	(*23) LOPEZ SALAS A. (NOR)
2	(*23) LOPEZ SALAS A. (NOR)			10	
3	(*20) ABDESSELEM R. (FRA)	#243	PTS	5	(*20) ABDESSELEM R. (FRA)
4	(*7) SHIMADA R. (JPN)			1	
5	(*23) LOPEZ SALAS A. (NOR)	#245	PTS	1	(*20) ABDESSELEM R. (FRA)
6	(*20) ABDESSELEM R. (FRA)			5	
7	(*19) MOHAMED O. (EGY)	#246	PTS	5	(*7) SHIMADA R. (JPN)
8	(*7) SHIMADA R. (JPN)			6	
9	(*19) MOHAMED O. (EGY)	#248	PTS	1	(*19) MOHAMED O. (EGY)
10	(*20) ABDESSELEM R. (FRA)			0	
11	(*23) LOPEZ SALAS A. (NOR)	#249	PTS	3	(*7) SHIMADA R. (JPN)
12	(*7) SHIMADA R. (JPN)			5	



1. ALJAFARI MOHAMMAD (JOR)
2. KVESIC IVAN (CRO)
3. ETO JUNYA (JPN)
3. CHOBOTAR VALERII (UKR)
5. ABDESSELEM RAYBAK (FRA)
5. TIMMERMANS BRIAN (NED)
7. YULDASHEV DANIYAR (KAZ)
7. FIORE MATTEO (ITA)

\*Seeded

Referees:			



# Male Kumite -84 Kg - Round Robin (each against each)

Karate1 Premier League - Fukuoka 2023, Fukuoka, JPN

Tatami

Pool  
4/8

1	(*13) WU C. (TPE)		
	#244	9	(*13) WU C. (TPE)
2	(*11) KULOVUORI B. (FIN)		
		0	
3	(*13) WU C. (TPE)		
	#250 PTS	1	(*2) ALJAFARI M. (JOR)
4	(*2) ALJAFARI M. (JOR)		
		11	
5	(*11) KULOVUORI B. (FIN)		
	#247 PTS	1	(*2) ALJAFARI M. (JOR)
6	(*2) ALJAFARI M. (JOR)		
		5	



1. ALJAFARI MOHAMMAD (JOR)
2. KVESIC IVAN (CRO)
3. ETO JUNYA (JPN)
3. CHOBOTAR VALERII (UKR)
5. ABDESSELEM RAYBAK (FRA)
5. TIMMERMANS BRIAN (NED)
7. YULDASHEV DANIYAR (KAZ)
7. FIORE MATTEO (ITA)

\*Seeded

Referees:			

# Male Kumite -84 Kg - Round Robin (each against each)

Karate1 Premier League - Fukuoka 2023, Fukuoka, JPN

Tatami

Pool  
5/8

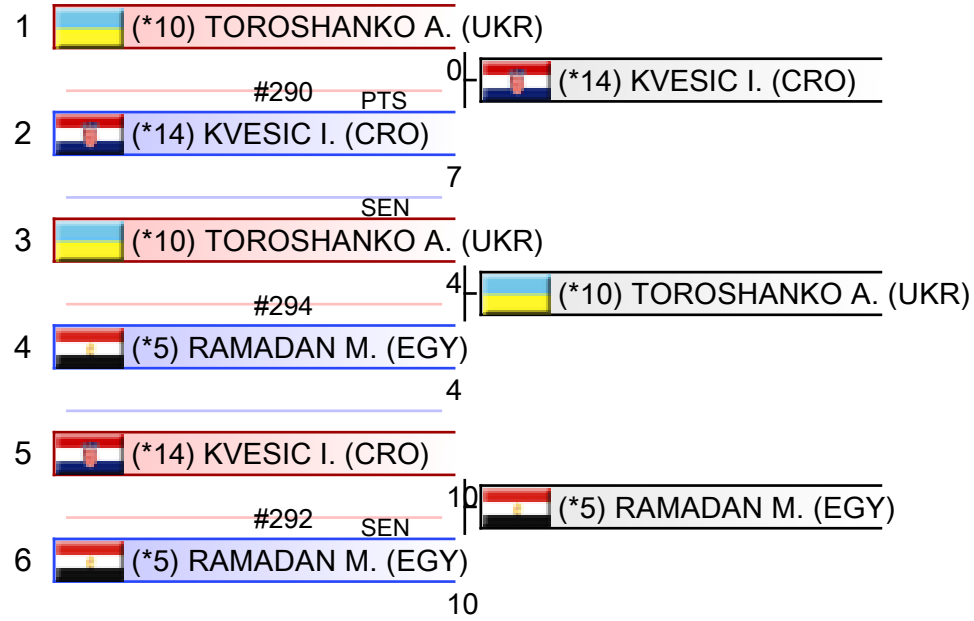

1. ALJAFARI MOHAMMAD (JOR)
2. KVESIC IVAN (CRO)
3. ETO JUNYA (JPN)
3. CHOBOTAR VALERII (UKR)
5. ABDESSELEM RAYBAK (FRA)
5. TIMMERMANS BRIAN (NED)
7. YULDASHEV DANIYAR (KAZ)
7. FIORE MATTEO (ITA)

\*Seeded









Referees:			

# Male Kumite -84 Kg - Round Robin (each against each)

Karate1 Premier League - Fukuoka 2023, Fukuoka, JPN

Tatami

Pool  
6/8

1	 (*9) ALNASHRI F. (KSA)	0	 (*21) RETTENBACHER L. (AUT)
	#291 PTS		
2	 (*21) RETTENBACHER L. (AUT)	1	
3	 (*9) ALNASHRI F. (KSA)	0	
4	 (*4) CHOBOTAR V. (UKR)	0	
5	 (*21) RETTENBACHER L. (AUT)	0	 (*4) CHOBOTAR V. (UKR)
	#293 PTS		
6	 (*4) CHOBOTAR V. (UKR)	2	



1. ALJAFARI MOHAMMAD (JOR)
2. KVESIC IVAN (CRO)
3. ETO JUNYA (JPN)
3. CHOBOTAR VALERII (UKR)
5. ABDESSELEM RAYBAK (FRA)
5. TIMMERMANS BRIAN (NED)
7. YULDASHEV DANIYAR (KAZ)
7. FIORE MATTEO (ITA)

\*Seeded















Referees:			

# Male Kumite -84 Kg - Round Robin (each against each)

Karate1 Premier League - Fukuoka 2023, Fukuoka, JPN

Tatami

Pool  
7/8

1	 (*24) PEREZ LUQUE V. (ESP)	
	#329 KI	
2	 (*15) MORI Y. (JPN)	
	PTS	
3	 (*12) DEGHALI W. (BEL)	
	#330	2  (*12) DEGHALI W. (BEL)
4	 (*8) FIORE M. (ITA)	
	PTS	0
5	 (*15) MORI Y. (JPN)	
	#332	1  (*15) MORI Y. (JPN)
6	 (*12) DEGHALI W. (BEL)	
	PTS	0
7	 (*24) PEREZ LUQUE V. (ESP)	
	#333 KI	
8	 (*8) FIORE M. (ITA)	
	PTS	
9	 (*24) PEREZ LUQUE V. (ESP)	
	PTS	
10	 (*12) DEGHALI W. (BEL)	
	PTS	
11	 (*15) MORI Y. (JPN)	
	#336 PTS	2  (*8) FIORE M. (ITA)
12	 (*8) FIORE M. (ITA)	
	PTS	5



1. ALJAFARI MOHAMMAD (JOR)
2. KVESIC IVAN (CRO)
3. ETO JUNYA (JPN)
3. CHOBOTAR VALERII (UKR)
5. ABDESSELEM RAYBAK (FRA)
5. TIMMERMANS BRIAN (NED)
7. YULDASHEV DANIYAR (KAZ)
7. FIORE MATTEO (ITA)

\*Seeded

Referees:			

# Male Kumite -84 Kg - Round Robin (each against each)

Karate1 Premier League - Fukuoka 2023, Fukuoka, JPN

Tatami

Pool  
8/8

1	(*26) AFIFUDDIN M. (MAS)	
	#331 PTS	1    (*17) BOUGRINE A. (BEL)
2	(*17) BOUGRINE A. (BEL)	7
	PTS	
3	(*26) AFIFUDDIN M. (MAS)	
	#337	7    (*26) AFIFUDDIN M. (MAS)
4	(*1) TIMMERMANS B. (NED)	6
5	(*17) BOUGRINE A. (BEL)	
	#334 PTS	1    (*1) TIMMERMANS B. (NED)
6	(*1) TIMMERMANS B. (NED)	3



1. ALJAFARI MOHAMMAD (JOR)
2. KVESIC IVAN (CRO)
3. ETO JUNYA (JPN)
3. CHOBOTAR VALERII (UKR)
5. ABDESSELEM RAYBAK (FRA)
5. TIMMERMANS BRIAN (NED)
7. YULDASHEV DANIYAR (KAZ)
7. FIORE MATTEO (ITA)

\*Seeded

Referees:			

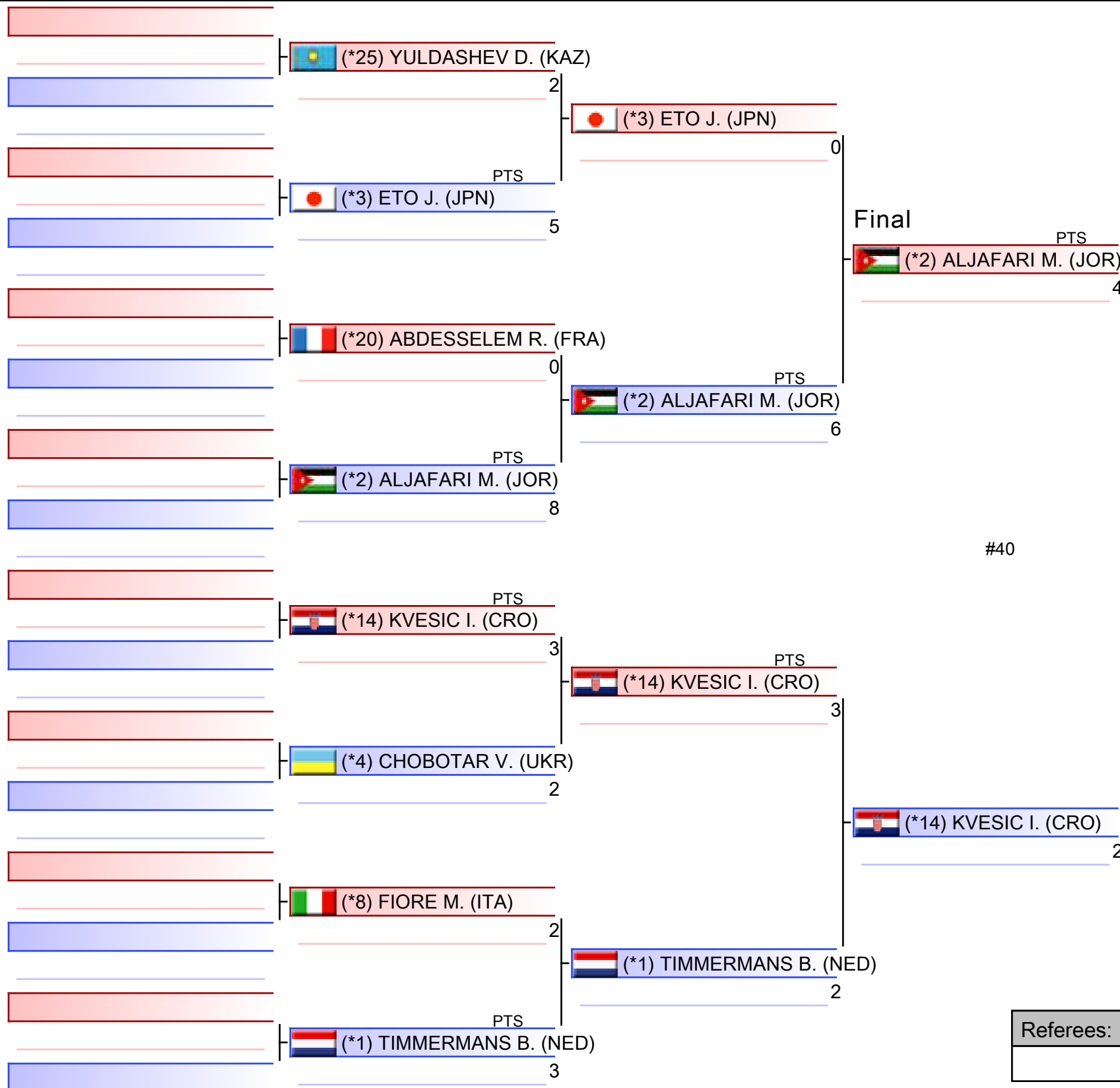

#40

1. ALJAFARI MOHAMMAD (JOR)
2. KVESIC IVAN (CRO)
3. ETO JUNYA (JPN)
3. CHOBOTAR VALERII (UKR)
5. ABDESSELEM RAYBAK (FRA)
5. TIMMERMANS BRIAN (NED)
7. YULDASHEV DANIYAR (KAZ)
7. FIORE MATTEO (ITA)

\*Seeded

Referees:			

# Male Kumite -84 Kg

Karate1 Premier League - Fukuoka 2023

Tatami

Pool

1,2,3,4,5,6,7,8

(c)sportdata GmbH & Co KG 2000-2023 (2023-06-11 18:09) v 10.0.1 build 1 (2023-05-19 20:00 CET) License: Online\_Event\_ID-705\_Karate1PremierLeagueFukuoka2023 (expire 2023-06-25)

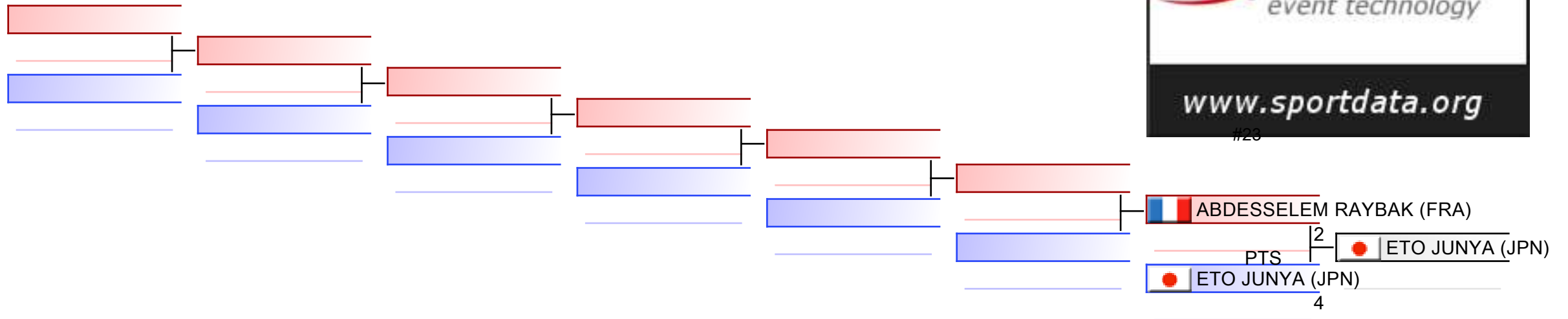

## REPECHAGE: (1,2,3,4,5,6,7,8)

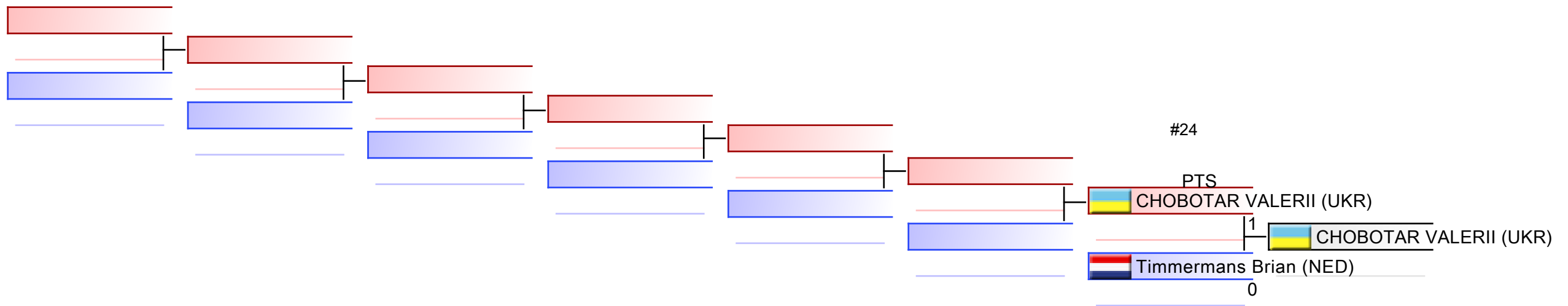



















Referees:							
-----------	--	--	--	--	--	--	--

# Male Kumite 84+ Kg - Round Robin (each against each)

Karate1 Premier League - Fukuoka 2023, Fukuoka, JPN

Tatami

Pool  
1/6

1	 (*15) AGUILERA F. (CAN)	
	#212	7    (*15) AGUILERA F. (CAN)
2	 (*17) FIRMANSYAH S. (INA)	0
3	 (*18) ANARBEKOV D. (KAZ)	
	#213 PTS	1    (*6) SUFYANI S. (KSA)
4	 (*6) SUFYANI S. (KSA)	7
5	 (*17) FIRMANSYAH S. (INA)	
	#214 PTS	0    (*18) ANARBEKOV D. (KAZ)
6	 (*18) ANARBEKOV D. (KAZ)	8
7	 (*15) AGUILERA F. (CAN)	
	#215 PTS	0    (*6) SUFYANI S. (KSA)
8	 (*6) SUFYANI S. (KSA)	9
	PTS	
9	 (*15) AGUILERA F. (CAN)	
	#216	2    (*15) AGUILERA F. (CAN)
10	 (*18) ANARBEKOV D. (KAZ)	0
11	 (*17) FIRMANSYAH S. (INA)	
	#217 PTS	1    (*6) SUFYANI S. (KSA)
12	 (*6) SUFYANI S. (KSA)	6



1. TALIBOV RYZVAN (UKR)
2. SECK SAKHO BABACAR (ESP)
3. ELMASRY AHMED (EGY)
3. TOLTAY ABYLAY (KAZ)
5. TIMMERMANS ROB (CUR)
5. SEKOT NIKOLAI (GER)
7. SUFYANI SANAD (KSA)
7. YELDASHOV NURNIYAZ (KAZ)

\*Seeded

Referees:			



# Male Kumite 84+ Kg - Round Robin (each against each)

Karate1 Premier League - Fukuoka 2023, Fukuoka, JPN

Tatami

Pool  
2/6

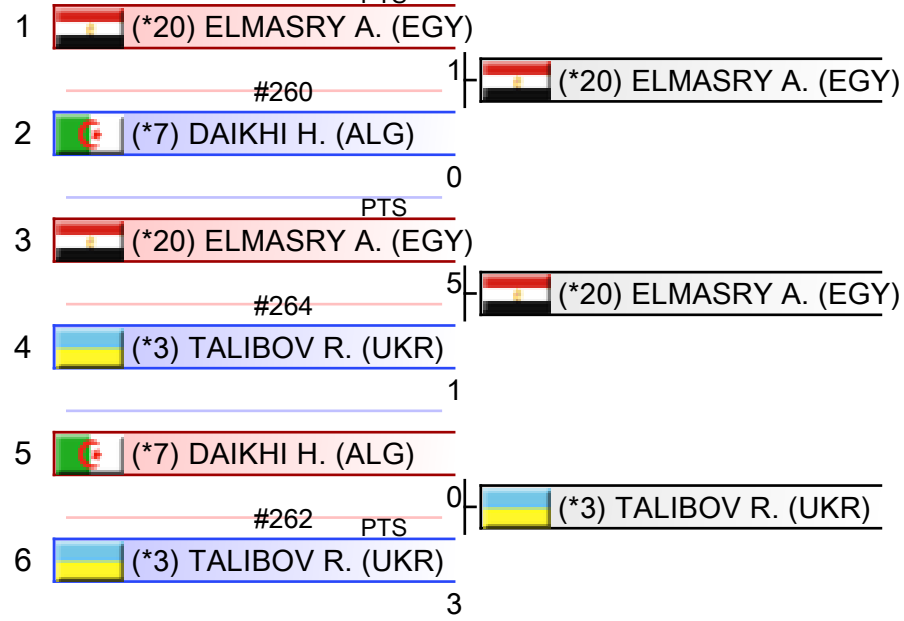

1. TALIBOV RYZVAN (UKR)
2. SECK SAKHO BABACAR (ESP)
3. ELMASRY AHMED (EGY)
3. TOLTAY ABYLAY (KAZ)
5. TIMMERMANS ROB (CUR)
5. SEKOT NIKOLAI (GER)
7. SUFYANI SANAD (KSA)
7. YELDASHOV NURNIYAZ (KAZ)

\*Seeded







Referees:			

# Male Kumite 84+ Kg - Round Robin (each against each)

Karate1 Premier League - Fukuoka 2023, Fukuoka, JPN

Tatami

Pool  
3/6

1	 (*19) PAPASTERGIOS K. (GER)	1
2	 (*13) ZITOUNI O. (ALG)	1
3	 (*19) PAPASTERGIOS K. (GER)	2
4	 (*2) TIMMERMANS R. (CUR)	8
5	 (*13) ZITOUNI O. (ALG)	0
6	 (*2) TIMMERMANS R. (CUR)	0



1. TALIBOV RYZVAN (UKR)
2. SECK SAKHO BABACAR (ESP)
3. ELMASRY AHMED (EGY)
3. TOLTAY ABYLAY (KAZ)
5. TIMMERMANS ROB (CUR)
5. SEKOT NIKOLAI (GER)
7. SUFYANI SANAD (KSA)
7. YELDASHOV NURNIYAZ (KAZ)

\*Seeded

Referees:			

# Male Kumite 84+ Kg - Round Robin (each against each)

Karate1 Premier League - Fukuoka 2023, Fukuoka, JPN

Tatami

Pool  
4/6

1	(*9) HIRATA K. (JPN)	
	#302	6    (*9) HIRATA K. (JPN)
2	(*16) MAZZOLENI F. (ITA)	
		5
3	(*8) FELIPIN SALGADO G. (BRA)	
	#303 PTS	7    (*5) YELDASHOV N. (KAZ)
4	(*5) YELDASHOV N. (KAZ)	
		13
5	(*16) MAZZOLENI F. (ITA)	
	#304 PTS	0    (*8) FELIPIN SALGADO G. (BRA)
6	(*8) FELIPIN SALGADO G. (BRA)	
		1
7	(*9) HIRATA K. (JPN)	
		2
8	(*5) YELDASHOV N. (KAZ)	
		2
	PTS	
9	(*9) HIRATA K. (JPN)	
	#306	6    (*9) HIRATA K. (JPN)
10	(*8) FELIPIN SALGADO G. (BRA)	
		4
11	(*16) MAZZOLENI F. (ITA)	
	#307 PTS	2    (*5) YELDASHOV N. (KAZ)
12	(*5) YELDASHOV N. (KAZ)	
		6



1. TALIBOV RYZVAN (UKR)
2. SECK SAKHO BABACAR (ESP)
3. ELMASRY AHMED (EGY)
3. TOLTAY ABYLAY (KAZ)
5. TIMMERMANS ROB (CUR)
5. SEKOT NIKOLAI (GER)
7. SUFYANI SANAD (KSA)
7. YELDASHOV NURNIYAZ (KAZ)

\*Seeded

Referees:			

# Male Kumite 84+ Kg - Round Robin (each against each)

Karate1 Premier League - Fukuoka 2023, Fukuoka, JPN

Tatami

Pool  
5/6

	PTS	
1		(*14) SEKOT N. (GER)
	#347	7    (*14) SEKOT N. (GER)
2		(*12) MARINO S. (ITA)
	PTS	5
3		(*14) SEKOT N. (GER)
	#351	4    (*14) SEKOT N. (GER)
4		(*4) HAMED T. (KSA)
	PTS	3
5		(*12) MARINO S. (ITA)
	#349	3    (*12) MARINO S. (ITA)
6		(*4) HAMED T. (KSA)
		0



1. TALIBOV RYZVAN (UKR)
2. SECK SAKHO BABACAR (ESP)
3. ELMASRY AHMED (EGY)
3. TOLTAY ABYLAY (KAZ)
5. TIMMERMANS ROB (CUR)
5. SEKOT NIKOLAI (GER)
7. SUFYANI SANAD (KSA)
7. YELDASHOV NURNIYAZ (KAZ)

\*Seeded









Referees:			

# Male Kumite 84+ Kg - Round Robin (each against each)

Karate1 Premier League - Fukuoka 2023, Fukuoka, JPN

Tatami

Pool  
6/6

1	 (*11) TOLTAY A. (KAZ)	
	#348	5    (*11) TOLTAY A. (KAZ)
2	 (*10) YOSHIMURA F. (JPN)	
	PTS	0
3	 (*11) TOLTAY A. (KAZ)	
	#352	5    (*11) TOLTAY A. (KAZ)
4	 (*1) SECK SAKHO B. (ESP)	
		0
5	 (*10) YOSHIMURA F. (JPN)	
	#350	1    (*1) SECK SAKHO B. (ESP)
	PTS	
6	 (*1) SECK SAKHO B. (ESP)	
		2



1. TALIBOV RYZVAN (UKR)
2. SECK SAKHO BABACAR (ESP)
3. ELMASRY AHMED (EGY)
3. TOLTAY ABYLAY (KAZ)
5. TIMMERMANS ROB (CUR)
5. SEKOT NIKOLAI (GER)
7. SUFYANI SANAD (KSA)
7. YELDASHOV NURNIYAZ (KAZ)

\*Seeded

Referees:			

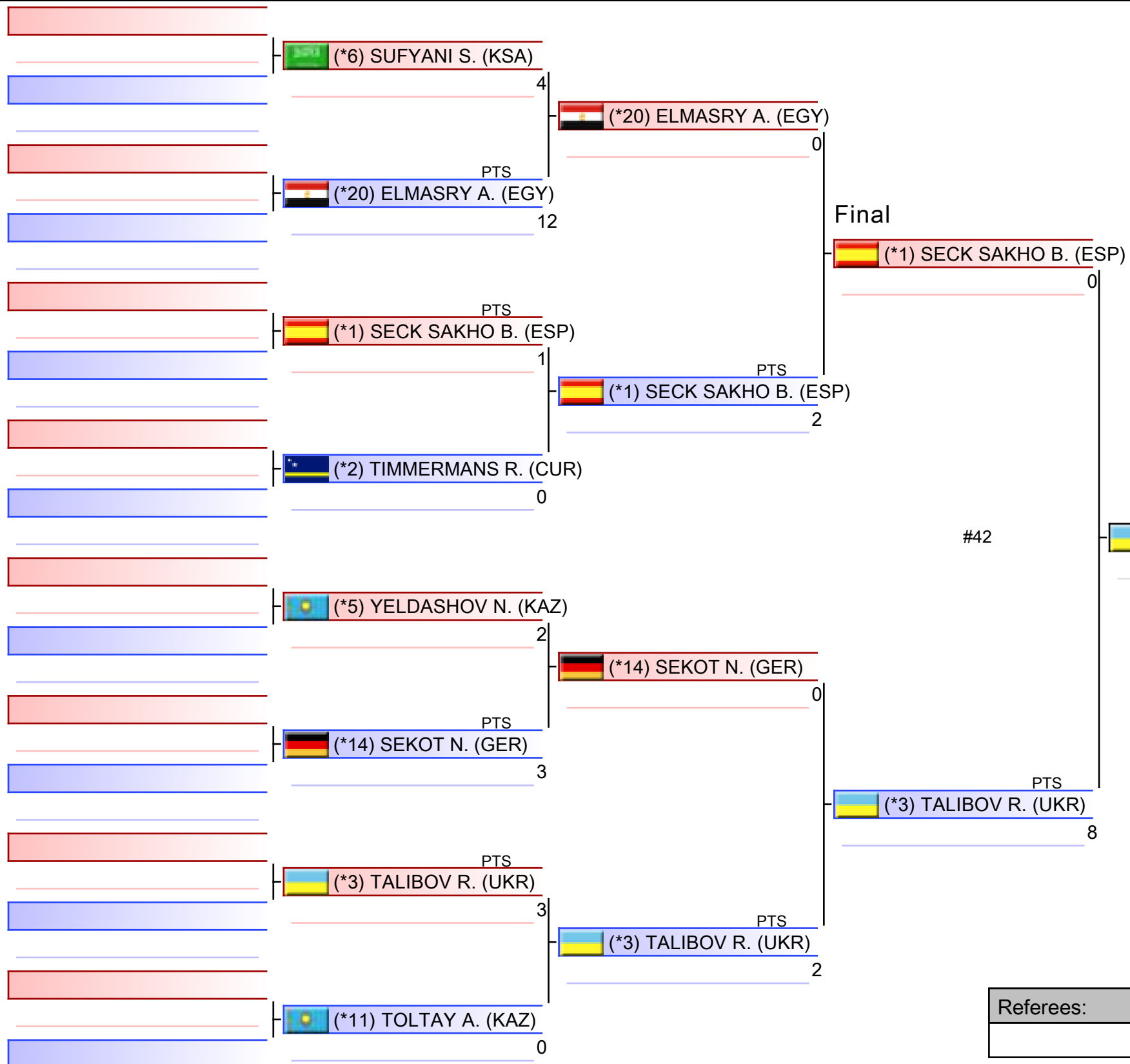

1. TALIBOV RYZVAN (UKR)
2. SECK SAKHO BABACAR (ESP)
3. ELMASRY AHMED (EGY)
3. TOLTAY ABYLAY (KAZ)
5. TIMMERMANS ROB (CUR)
5. SEKOT NIKOLAI (GER)
7. SUFYANI SANAD (KSA)
7. YELDASHOV NURNIYAZ (KAZ)

\*Seeded

Referees:			

# Male Kumite 84+ Kg

Karate1 Premier League - Fukuoka 2023

Tatami

Pool  
1,2,3,4,5,6

(c)sportdata GmbH & Co KG 2000-2023 (2023-06-11 18:09) v 10.0.1 build 1 (2023-05-19 20:00 CET) License: Online\_Event\_ID-705\_Karate1PremierLeagueFukuoka2023 (expire 2023-06-25)

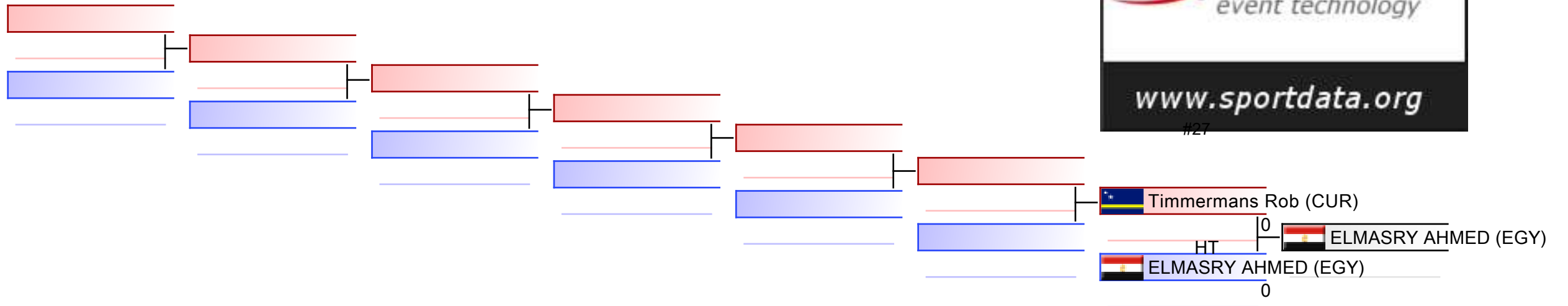

## REPECHAGE: (1,2,3,4,5,6)

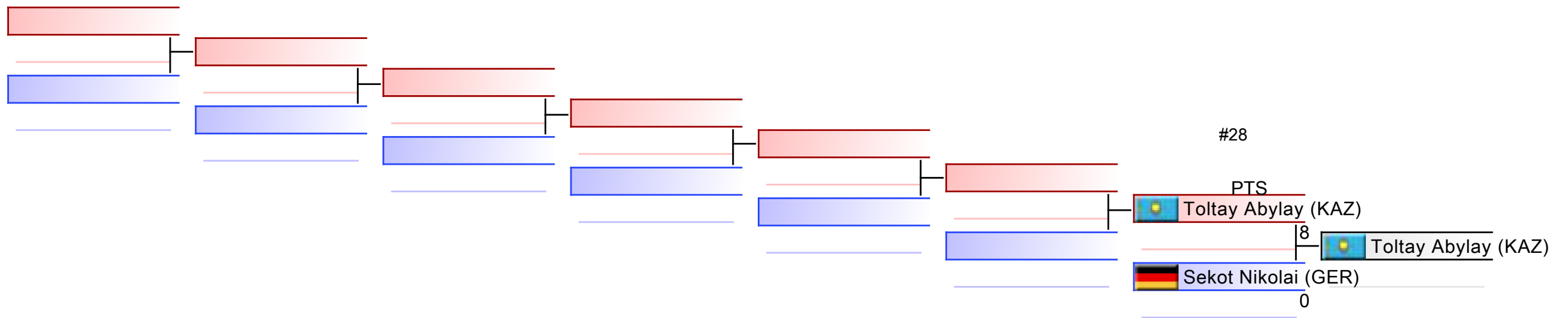

Referees:							
-----------	--	--	--	--	--	--	--



## Official Results

Female Kata			
1	ONO HIKARU		JPN - JAPAN
2	LAU MO SHEUNG GRACE		HKG - HONG KONG, CHINA
3	OHUCHI MIRISA		JPN - JAPAN
3	SHIMIZU KIYOU		JPN - JAPAN
5	SHIMIZU NATSUKI		JPN - JAPAN
5	YAMADA NODOKA		JPN - JAPAN
7	KOKUMAI SAKURA		USA - UNITED STATES
7	ONO MAHO		JPN - JAPAN

Female Kumite -50 Kg			
1	SALAMA REEM AHMED		EGY - EGYPT
2	GOMEZ MORALES NADIA		ESP - SPAIN
3	ZHANGBYRBAY MOLDIR		KAZ - KAZAKHSTAN
3	SALAZAR YORGELIS		VEN - VENEZUELA
5	TSANG YEE TING		HKG - HONG KONG, CHINA
5	TSUTSUMI SARA		JPN - JAPAN
7	KRYVA KATERYNA		UKR - UKRAINE
7	PALASHEVSKA YULIIA		UKR - UKRAINE

Female Kumite -55 Kg			
1	TERLIUGA ANZHELIKA		UKR - UKRAINE
2	NAKAMURA SHIORI		JPN - JAPAN
3	SCHAERER MAYA		SUI - SWITZERLAND
3	USSENOVA GULMIRA		KAZ - KAZAKHSTAN
5	BUGUR GIZEM		GER - GERMANY
5	KU TSUI-PING		TPE - CHINESE TAIPEI
7	ALLEN TRINITY		USA - UNITED STATES
7	FURUMOTO-DESHAIES HANA		CAN - CANADA

Female Kumite -61 Kg			
1	SHIMADA SARARA		JPN - JAPAN
2	KHAMIS REEM		GER - GERMANY
3	SEROGINA ANITA		UKR - UKRAINE
3	KUJURO YUKI		JPN - JAPAN
5	NILSSON ANNA-JOHANNA		SWE - SWEDEN
5	SUZUKI MAYA		JPN - JAPAN
7	KANAY ASSEL		KAZ - KAZAKHSTAN
7	FACTOS JACQUELIN		ECU - ECUADOR

Female Kumite -68 Kg			
1	QUIRICI ELENA		SUI - SWITZERLAND
2	KAMA TSUBASA		JPN - JAPAN
3	ALIKUL LAURA		KAZ - KAZAKHSTAN
3	ZARETSKA IRYNA		AZE - AZERBAIJAN
5	SOMEYA KAYO		JPN - JAPAN





## Official Results

5	ZHAXYBAYEVA VENERA		KAZ - KAZAKHSTAN	
7	RIEDEL HANNAH		GER - GERMANY	
7	SCHROETER MADELEINE		GER - GERMANY	

## Female Kumite 68+ Kg

1	SAWAE YUZUKI		JPN - JAPAN	
2	SAITO AYAKA		JPN - JAPAN	
3	BERULTSEVA SOFYA		KAZ - KAZAKHSTAN	
3	TORRES GARCIA MARIA		ESP - SPAIN	
5	GABALLA ZEYNA		TUR - TURKIYE	
5	ABOUIMAIL SOHILA		EGY - EGYPT	
7	KEINANEN TITTA		FIN - FINLAND	
7	UEKUSA AYUMI		JPN - JAPAN	

## Male Kata

1	MOTO KAZUMASA		JPN - JAPAN	
2	KIKUCHI RYONOSUKE		JPN - JAPAN	
3	QUINTERO CAPDEVILA DAMIAN HUGO		ESP - SPAIN	
3	NISHIYAMA KAKERU		JPN - JAPAN	
5	TORRES GUTIERREZ ARIEL		USA - UNITED STATES	
5	TOZAKI GAKUJI		USA - UNITED STATES	
7	FUNADA AOI		JPN - JAPAN	
7	ABE SAKICHI		JPN - JAPAN	

## Male Kumite -60 Kg

1	HASHIMOTO HIROMU		JPN - JAPAN	
2	TIMRALIYEV DARKHAN		KAZ - KAZAKHSTAN	
3	HARI SANKAR SUREEYA SANKAR		MAS - MALAYSIA	
3	HAAS FLORIAN		GER - GERMANY	
5	SHAABAN ABDULLAH		KUW - KUWAIT	
5	SHAQRAH OMAR		JOR - JORDAN	
7	DASOUL MICHAEL		BEL - BELGIUM	
7	HAMMAD ABDALLAH		JOR - JORDAN	

## Male Kumite -67 Kg

1	ALMASATFA ABDEL RAHMAN		JOR - JORDAN	
2	GHAITH AFEEF		JOR - JORDAN	
3	AMIRALI DIDAR		KAZ - KAZAKHSTAN	
3	XENOS DIONYSIOS		GRE - GREECE	
5	YANOVSKYI DAVYD		UKR - UKRAINE	
5	KOZAKI YUGO		JPN - JAPAN	
7	NAKANO HIROKI		JPN - JAPAN	
7	NAKANO SOICHIRO		JPN - JAPAN	

## Male Kumite -75 Kg

1	PIETROMARCHI LORENZO		ITA - ITALY	
2	YURUR OMER FARUK		TUR - TURKIYE	



## Official Results

3	MAHAUDEN QUENTIN		BEL - BELGIUM	
3	DE VIVO DANIELE		ITA - ITALY	
5	AZHIKANOV NURKANAT		KAZ - KAZAKHSTAN	
5	ZAPLITNYI ANDRII		UKR - UKRAINE	
7	ABDELGAWAD ABDALLA HESHAM		EGY - EGYPT	
7	SAKIYAMA YUSEI		JPN - JAPAN	

## Male Kumite -84 Kg

1	ALJAFARI MOHAMMAD		JOR - JORDAN	
2	KVESIC IVAN		CRO - CROATIA	
3	ETO JUNYA		JPN - JAPAN	
3	CHOBOTAR VALERII		UKR - UKRAINE	
5	ABDESSELEM RAYBAK		FRA - FRANCE	
5	TIMMERMANS BRIAN		NED - NETHERLANDS	
7	YULDASHEV DANIYAR		KAZ - KAZAKHSTAN	
7	FIORE MATTEO		ITA - ITALY	

## Male Kumite 84+ Kg

1	TALIBOV RYZVAN		UKR - UKRAINE	
2	SECK SAKHO BABACAR		ESP - SPAIN	
3	ELMASRY AHMED		EGY - EGYPT	
3	TOLTAY ABYLAY		KAZ - KAZAKHSTAN	
5	TIMMERMANS ROB		CUR - CURACAO	
5	SEKOT NIKOLAI		GER - GERMANY	
7	SUFYANI SANAD		KSA - SAUDI ARABIA	
7	YELDASHOV NURNIYAZ		KAZ - KAZAKHSTAN	